

In the event that a problem should arise,  
DO NOT RETURN TO THE STORE,  
please contact:  
Horizon Fitness @ 1-888-993-3199  
OR  
www.horizonfitness.com



Horizon Fitness  
800 Burton Blvd  
DeForest, Wisconsin 53532  
Ph: 1-888-993-3199 Fax: 1-608-842-1660  
www.horizonfitness.com

IMPORTANT SAFETY INSTRUCTIONS  
SAVE THESE INSTRUCTIONS

# Owner's & Assembly Guide

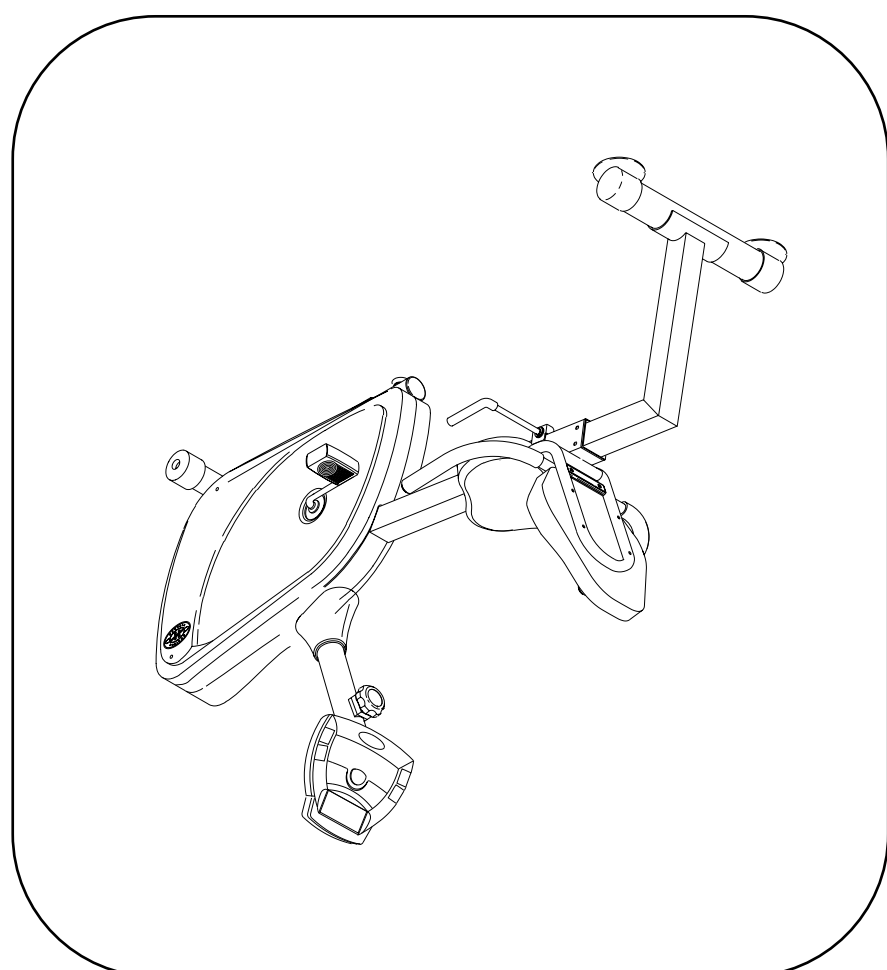

AVALON EXERCISE BIKE



How do I clean my Horizon Fitness Exercise Bike?  
Clean with soap and water cleaners only. Never use solvents on plastic parts.

What kind of routine maintenance is required?  
We use sealed bearings throughout our Exercise Bike so lubrication is not needed. The most important maintenance step is to simply wipe your perspiration off the Exercise Bike after each use.

Can I move the trainer easily once it is assembled?  
Yes, the Horizon Fitness Exercise Bike has a pair of transport wheels built into the front legs. It is easy to move your Exercise Bike by rolling it on the front transport wheels. It is important that you place your Horizon Fitness Exercise Bike in a comfortable and inviting room. Your Exercise Bike is designed to use minimal floor space. Many people will place their Exercise Bike facing the TV or a picture window. If at all possible, avoid putting your Exercise Bike in a unfinished basement. To make exercise a desirable daily activity for you, the Exercise Bike should be in an attractive setting.

How long will the drive belt last?  
The computer modeling we have done indicated virtually thousands of maintenance free hours. Belts are now commonly used in far more demanding applications such as motorcycle drives.

When should I be worried about a noise?  
As long as the sounds your Exercise Bike makes are no louder than a normal conversational tone of voice, it is considered normal noise. If your Exercise Bike is louder than this, you may want to call your service technician. Sometimes an initial diagnosis can be made over the phone.

Why is the Exercise Bike I had delivered louder than the one at the store?  
All fitness products seem quieter in a large store showroom because there is generally more background noise than in your home. Also, there will be less reverberation on a carpeted floor than on a wood overlay floor. Sometimes a heavy rubber mat will help reduce reverberation through the floor. If a fitness product is placed close to a wall, there will be more reflected noise.

Are the sounds my Exercise Bike makes normal?  
Our Exercise Bike are some of the quietest available because they use belt drives and friction free magnetic resistance. We use the highest grade bearings and belts to minimize noise. However, because the resistance system itself is so quiet, you will occasionally hear other slight mechanical noises. Unlike older, louder technologies, there are no fans, friction belts, or alternator noises to mask these sounds on our Exercise Bike. These mechanical noises, which may or may not be intermittent, are normal and are caused by the transfer of significant amounts of energy to a rapidly spinning flywheel. All bearings, belts and other rotating parts will generate some noise which will transmit through the casing and frame. It is also normal for these sounds to change slightly during a workout and over time because of thermal expansion of the parts.

Why should I be worried about a noise?  
As long as the sounds your Exercise Bike makes are no louder than a normal conversational tone of voice, it is considered normal noise. If your Exercise Bike is louder than this, you may want to call your service technician. Sometimes an initial diagnosis can be made over the phone.

How long will the drive belt last?  
The computer modeling we have done indicated virtually thousands of maintenance free hours. Belts are now commonly used in far more demanding applications such as motorcycle drives.

When should I be worried about a noise?  
As long as the sounds your Exercise Bike makes are no louder than a normal conversational tone of voice, it is considered normal noise. If your Exercise Bike is louder than this, you may want to call your service technician. Sometimes an initial diagnosis can be made over the phone.

Why is the Exercise Bike I had delivered louder than the one at the store?  
All fitness products seem quieter in a large store showroom because there is generally more background noise than in your home. Also, there will be less reverberation on a carpeted floor than on a wood overlay floor. Sometimes a heavy rubber mat will help reduce reverberation through the floor. If a fitness product is placed close to a wall, there will be more reflected noise.

Are the sounds my Exercise Bike makes normal?  
Our Exercise Bike are some of the quietest available because they use belt drives and friction free magnetic resistance. We use the highest grade bearings and belts to minimize noise. However, because the resistance system itself is so quiet, you will occasionally hear other slight mechanical noises. Unlike older, louder technologies, there are no fans, friction belts, or alternator noises to mask these sounds on our Exercise Bike. These mechanical noises, which may or may not be intermittent, are normal and are caused by the transfer of significant amounts of energy to a rapidly spinning flywheel. All bearings, belts and other rotating parts will generate some noise which will transmit through the casing and frame. It is also normal for these sounds to change slightly during a workout and over time because of thermal expansion of the parts.

Why is the Exercise Bike I had delivered louder than the one at the store?  
All fitness products seem quieter in a large store showroom because there is generally more background noise than in your home. Also, there will be less reverberation on a carpeted floor than on a wood overlay floor. Sometimes a heavy rubber mat will help reduce reverberation through the floor. If a fitness product is placed close to a wall, there will be more reflected noise.

Are the sounds my Exercise Bike makes normal?  
Our Exercise Bike are some of the quietest available because they use belt drives and friction free magnetic resistance. We use the highest grade bearings and belts to minimize noise. However, because the resistance system itself is so quiet, you will occasionally hear other slight mechanical noises. Unlike older, louder technologies, there are no fans, friction belts, or alternator noises to mask these sounds on our Exercise Bike. These mechanical noises, which may or may not be intermittent, are normal and are caused by the transfer of significant amounts of energy to a rapidly spinning flywheel. All bearings, belts and other rotating parts will generate some noise which will transmit through the casing and frame. It is also normal for these sounds to change slightly during a workout and over time because of thermal expansion of the parts.

Why is the Exercise Bike I had delivered louder than the one at the store?  
All fitness products seem quieter in a large store showroom because there is generally more background noise than in your home. Also, there will be less reverberation on a carpeted floor than on a wood overlay floor. Sometimes a heavy rubber mat will help reduce reverberation through the floor. If a fitness product is placed close to a wall, there will be more reflected noise.

Are the sounds my Exercise Bike makes normal?  
Our Exercise Bike are some of the quietest available because they use belt drives and friction free magnetic resistance. We use the highest grade bearings and belts to minimize noise. However, because the resistance system itself is so quiet, you will occasionally hear other slight mechanical noises. Unlike older, louder technologies, there are no fans, friction belts, or alternator noises to mask these sounds on our Exercise Bike. These mechanical noises, which may or may not be intermittent, are normal and are caused by the transfer of significant amounts of energy to a rapidly spinning flywheel. All bearings, belts and other rotating parts will generate some noise which will transmit through the casing and frame. It is also normal for these sounds to change slightly during a workout and over time because of thermal expansion of the parts.

Why is the Exercise Bike I had delivered louder than the one at the store?  
All fitness products seem quieter in a large store showroom because there is generally more background noise than in your home. Also, there will be less reverberation on a carpeted floor than on a wood overlay floor. Sometimes a heavy rubber mat will help reduce reverberation through the floor. If a fitness product is placed close to a wall, there will be more reflected noise.

Are the sounds my Exercise Bike makes normal?  
Our Exercise Bike are some of the quietest available because they use belt drives and friction free magnetic resistance. We use the highest grade bearings and belts to minimize noise. However, because the resistance system itself is so quiet, you will occasionally hear other slight mechanical noises. Unlike older, louder technologies, there are no fans, friction belts, or alternator noises to mask these sounds on our Exercise Bike. These mechanical noises, which may or may not be intermittent, are normal and are caused by the transfer of significant amounts of energy to a rapidly spinning flywheel. All bearings, belts and other rotating parts will generate some noise which will transmit through the casing and frame. It is also normal for these sounds to change slightly during a workout and over time because of thermal expansion of the parts.

Why is the Exercise Bike I had delivered louder than the one at the store?  
All fitness products seem quieter in a large store showroom because there is generally more background noise than in your home. Also, there will be less reverberation on a carpeted floor than on a wood overlay floor. Sometimes a heavy rubber mat will help reduce reverberation through the floor. If a fitness product is placed close to a wall, there will be more reflected noise.

Are the sounds my Exercise Bike makes normal?  
Our Exercise Bike are some of the quietest available because they use belt drives and friction free magnetic resistance. We use the highest grade bearings and belts to minimize noise. However, because the resistance system itself is so quiet, you will occasionally hear other slight mechanical noises. Unlike older, louder technologies, there are no fans, friction belts, or alternator noises to mask these sounds on our Exercise Bike. These mechanical noises, which may or may not be intermittent, are normal and are caused by the transfer of significant amounts of energy to a rapidly spinning flywheel. All bearings, belts and other rotating parts will generate some noise which will transmit through the casing and frame. It is also normal for these sounds to change slightly during a workout and over time because of thermal expansion of the parts.

**Congratulations** on choosing a Horizon Fitness Exercise Bike. You've taken an important step in developing and sustaining an exercise program! Your Horizon Fitness Exercise Bike is a tremendously effective tool for achieving your personal fitness goals. Regular use of your Horizon Fitness Exercise Bike can improve the quality of your life in so many ways.

Here are just a few of the health benefits of aerobic exercise:

- Weight Loss
- A Healthier Heart
- Improved Muscle Tone
- Increased Daily Energy Levels
- Reduced Stress
- Help In Counteracting Anxiety and Depression
- An Improved Self Image

The key to reaping these benefits is to develop the exercise habit. Your new Horizon Fitness Exercise Bike will help you eliminate the obstacles that prevent you from getting in your exercise time. Inclement weather and darkness won't interfere with your workout when you use your Horizon Fitness Exercise Bike in the comfort of your home. This manual provides you with basic information for using and enjoying your new machine. A more complete knowledge of your new Horizon Fitness Exercise Bike will assist you in realizing your goal of a healthy lifestyle.

**CAUTION:**  
BEFORE BEGINNING ANY EXERCISE PROGRAM, ALWAYS CONSULT YOUR PHYSICIAN. IF YOU EXPERIENCE CHEST PAINS, NAUSEA, DIZZINESS OR SHORTNESS OF BREATH, STOP EXERCISING AND CONSULT YOUR PHYSICIAN BEFORE CONTINUING.

## USING YOUR BIKE

### Getting started

The console on your exercise bike is powered by 2 AA batteries, which are replaceable through the back side of the console. Your exercise bike itself, is powered by you. The speed readout on the console automatically defaults to mph when installing the batteries. To convert the speed readout to kilometers, press and hold the 'Select' button for three seconds. At this time, the time display should register 0:00. Continue to press the 'Select' button for an additional 2 seconds until the time display registers 0:00 once again. The console should now be set for km. To switch back to mph, simply remove the batteries in the console. To begin exercising on your bike:

1. Sit down and place your feet on the pedals.
2. Press the 'Select' button or begin pedaling to turn on the console.
3. Once the console is lit, and you begin to pedal, the time will begin to count up. **Note:** the time can not be set to a specific time.

### Scan Function

During a workout, you can view alternate information such as speed, distance, calories, accumulated distance (odometer), and heart rate by pressing the 'Select' button. To continuously scan through all alternate readouts, press the 'Select' button until both Scan and Time are displayed. This will automatically allow the console to scan through all alternate readouts.

### Resetting the Console

Press and hold the 'Select' button to reset any accumulated information. In order to reset the Odometer reading (accumulated distance), the batteries must be removed from the back of the console.

### Heart Rate Function

Your console has two built-in heart rate grips. To view your heart rate reading, press the 'Select' button until the heart icon is showing on the display. Place the palms of your hands directly on the heart rate grips. When holding the heart rate grips, keep a loose, cupping hold. Holding the grips too tightly may cause an erratic heart rate reading. It is recommended to only hold the heart rate grips long enough to see your heart rate reading on the console. You may experience an erratic readout if consistently holding the heart rate grips due to movement and vibration.

### Warning!

To stop your workout, gradually slow down your pace. Remember you should never stop exercising abruptly. After you have completed your workout the console will retain the data from your workout until the console is reset. To conserve batteries, the console will automatically shut off after a short period of time.

### SERIAL NUMBER AND MODEL NAME LOCATION:

Refer to this number when calling for service, and also enter this serial number on your Warranty Card and in your own records. Be sure to read the Safety Instructions and Owner's Guide before using your new Horizon Fitness Exercise Bike.

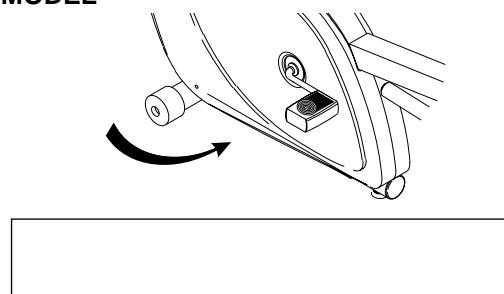

## Your Horizon Fitness Exercise Bike is the ideal choice to help you maintain year round fitness.

You can use your Horizon Fitness Exercise Bike as the core of your exercise program, or as a supplement to other fitness activities. Many people will ride their bikes, hike, or swim in the more pleasant months, only to lose their improved fitness with the arrival of inclement weather. By placing a Horizon Fitness Exercise Bike in the convenience of your home, you can keep your exercise program going despite bad weather, early nightfalls, or an ever increasingly busy schedule.

### How Often?

The American Heart Association recommends that you exercise at least 3 to 4 days per week to maintain cardiovascular fitness. If you have other goals such as weight or fat loss, you will achieve your goal faster with more frequent exercise. Whether it's 3 days or 6 days, remember that your ultimate goal should be to make exercise a lifetime habit. Many people are successful staying with a fitness program if they set aside a specific time of day to exercise. It doesn't matter whether it's in the morning before your shower, during lunch hour or while watching the evening news. What's more important is that it's a time that allows you to keep a schedule, and a time when you won't be interrupted. If you are to be successful with your fitness program, you have to make it a priority in your life. So decide on a time, pull out your day planner and pencil in your exercise times for the next month!

### How Long?

For aerobic exercise benefits, it's recommended that you exercise from between 24 and 32 minutes per session. But start slowly and gradually increase your exercise times. If you've been sedentary during the past year, it may be a good idea to keep your exercise times to as little as five minutes initially. Your body will need time to adjust to the new activity. If your goal is weight loss, a longer exercise session at lower intensities has been found to be most effective.

### How Hard?

How hard you workout is also determined by your goals. If you use your Horizon Fitness Exercise Bike to prepare for bicycle racing, you will probably workout at a higher intensity than if your goal is general fitness. Regardless of your long term goals, always begin an exercise program at low intensity. Aerobic exercise does not have to be painful to be beneficial! There are two ways to measure your exercise intensity. The first is by monitoring your heart rate, and the second is by evaluating your perceived exertion level (this is simpler than it sounds!).

### Monitor your heart rate

You can measure your pulse with your fingers by placing your first two fingers lightly over the blood vessel (carotid artery) on your neck located next to your Adam's apple. Count your pulse for ten seconds and multiply by six. This figure is your heart rate in beats per minute. Compare this number to the Target Heart Rate Zone for your age group.

### Perceived Exertion Level

The second and simpler way to gauge your exercise intensity is to evaluate your perceived exertion level. If while exercising you are too winded to maintain a conversation without gasping, you are working out too hard. A good rule of thumb is to work to the point of exhilaration, not exhaustion. If you cannot catch your breath, it's time to slow down. Always be aware of other warning signs to overexertion.

### SAFETY! IMPORTANT SAFETY INSTRUCTIONS. SAVE THESE INSTRUCTIONS

Read all instructions before using this Exercise Bike.

1. Use this Exercise Bike for its intended use as described in this manual. Use only attachments recommended by the manufacturer.
2. Never drop or insert any object into any opening.
3. Do not remove the Exercise Bike side covers. Service should be performed only by an authorized Horizon Fitness Service Technician.

### CHILDREN

- Keep children off your Exercise Bike at all times.
- When the Exercise Bike is in use, young children and pets should be kept at least 10 feet away.

### CAUTION!

- If you experience chest pains, nausea, dizziness or shortness of breath, stop exercising immediately and consult your physician before continuing.
- Do not turn pedal arms by hand.
- Do not wear clothing that might catch on any part of the Exercise Bike.
- Make sure all bolts are secure before each use.
- Read this manual before operating this Exercise Bike.
- Maintain a comfortable pace. Do not "sprint" above 120 rpm on this machine.

In the event that a problem should arise, DO NOT RETURN TO THE STORE, please contact:  
Horizon Fitness @ 1-888-993-3199 or www.horizonfitness.com



AVALON

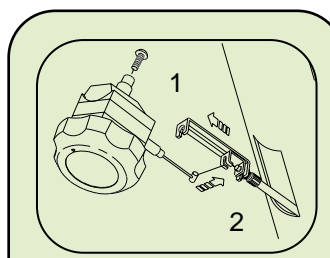
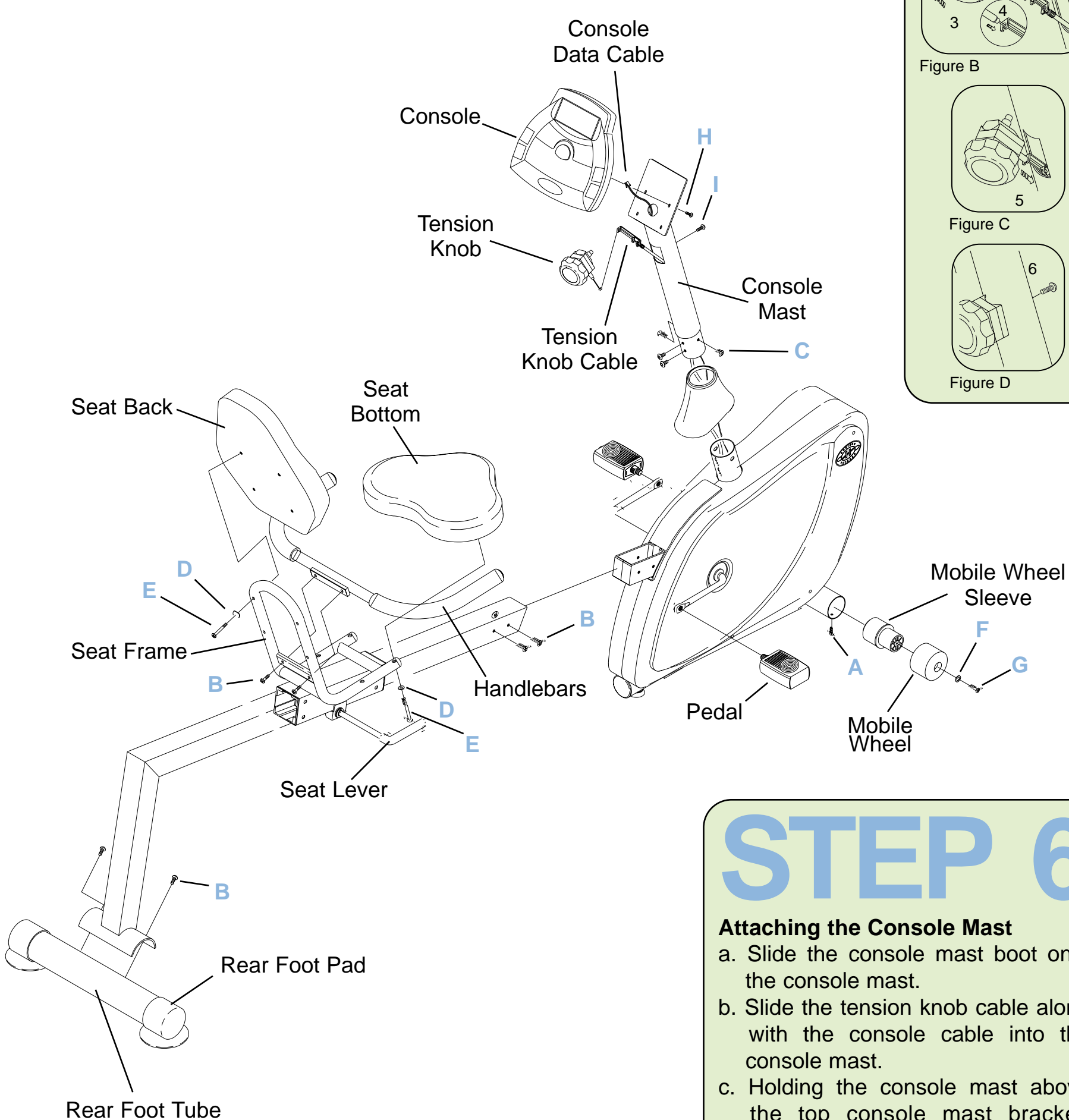

Figure A

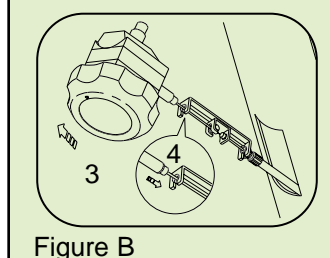

Figure B

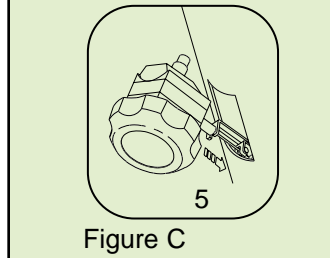

Figure C

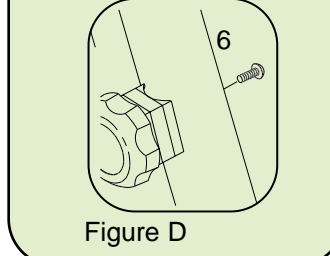

Figure D

# STEP 1

## Attach the Foot Wheels

- Insert the wheel sleeves on each side of the front wheel tube.
- Align the holes in the wheel sleeves with the holes in the wheel tube. Insert two 12mm screws (A) and secure with a screwdriver.
- Attach the mobile wheels to the wheel sleeves. Insert two 14mm washers (F) and two 20mm bolts (G) and secure with a screwdriver.

# STEP 2

## Attach the Rear Foot

- Align the holes of the rear foot tube with the holes on the seat rail.
- Insert two 20mm bolts (B) and secure with a 5mm allen wrench.

# STEP 3

## Attaching the Handlebars

- Attach the handlebars to the seat frame using two 20mm bolts (B). Secure with a 5mm allen wrench.

# STEP 4

## Attach the Seat Back and Bottom

- Align the holes in the seat frame with the holes in the seat bottom.
- Insert four washers (D) and four 40mm bolts (E) and secure with a 5mm allen wrench.
- Align the holes in the seat frame with the holes in the seat back.
- Insert four washers (D) and four 40mm bolts (E) and secure with a 5mm allen wrench.

# STEP 5

## Attach the Seat Rail and Frame

- Slide the seat frame onto the seat rail.
- Slide the seat rail onto the main frame bracket until the holes on the seat rail and main frame bracket are aligned.
- Insert four 20mm bolts (B) and secure with a 5mm allen wrench.

# STEP 6

## Attaching the Console Mast

- Slide the console mast boot onto the console mast.
- Slide the tension knob cable along with the console cable into the console mast.
- Holding the console mast above the top console mast bracket, guide both cables through the console mast while simultaneously sliding the console mast onto the console mast bracket. Continue to guide the console cable through the top of the console mast.
- Insert four 15mm bolts (C) and secure with a 5mm allen wrench.
- Slide the console mast boot down to cover the bolt heads.

# STEP 9

## Connecting the Tension Knob

- Remove the 20mm long bolt (I) on the back of the tension knob.
- Turn the tension knob to level 15. Connect the tension knob to the bottom of the tension knob cable (Figure A, Step 2).
- Grasp the tension knob and firmly pull the tension knob assembly away from the machine in order to attach to the top of the tension knob cable (Figure B, Step 3). Make sure that the copper cable end is seated properly into the "key hole".
- Insert the tension knob into the rectangular opening on the console mast (Figure C, Step 5).
- Secure the tension knob with the 20mm bolt (I) by using a screw driver (Figure D, Step 6).

# STEP 8

## Attach the Pedals

- Thread the right pedal into the right side pedal crank arm. Note: The pedals are labeled on the end of the threaded shaft for reference.
- Tighten the pedal with the flat wrench.
- Repeat this process on the left side.

# STEP 7

## Attaching the Console

- Open the battery cover on the back of the console, insert two AA batteries into the console and replace the battery cover.
- Connect the cable from the console to the console cable running through the console mast, making sure that both ends snap together tight.
- Attach the console to the console mast plate with the 15mm screws (H). Secure using a screwdriver. Note: Screws (H) are located on the back side of the console.

## UNPACKING

Unpack your Exercise Bike where you will be using it. Place your bike on a level flat surface. It is recommended that you place a protective covering on your floor. You will only need to attach the following items. Verify that the following parts and tools are included:

- |   |  |
|---|--|
| <b>Parts</b>                              | <b>Tools (included)</b>                  |
| • 1 Rear Foot Tube                        | • 5mm Allen Wrench/Phillips Screw Driver |
| • 1 Handlebar Set                         | • Flat Wrench                            |
| • 1 Seat Rail                             |  |
| • 1 Seat Back                             |  |
| • 1 Seat Bottom                           |  |
| • 1 Seat Frame                            |  |
| • 1 Console Mast                          |  |
| • 1 Console Mast Boot                     |  |
| • 2 Mobile Wheels                         |  |
| • 1 Console                               |  |
| • 2 AA Batteries                          |  |
| • 2 Pedals                                |  |
| • 2 Wheel Sleeves                         |  |
| • 1 Tension Knob                          |  |
| • 1 Hardware Pack (contents listed below) |  |

## Hardware (Actual Size)

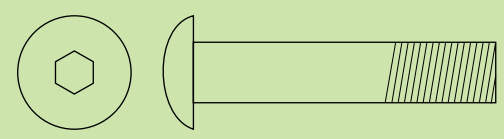

E) 40mm Bolt  
Quantity: 8

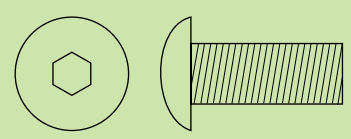

B) 20mm Bolt  
Quantity: 8

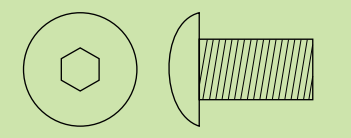

C) 15mm Bolt  
Quantity: 4

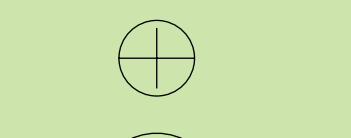

G) 20mm Bolt  
Quantity: 2

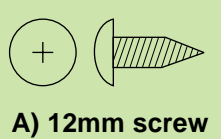

A) 12mm screw  
Quantity: 2

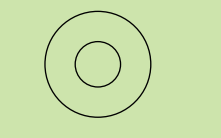

F) 14mm Washer  
Quantity: 2

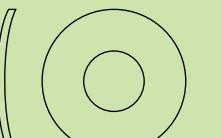

D) Washer  
Quantity: 8

**NOTE:** It is recommended that you apply grease to the threads of each bolt as you assemble your Exercise Bike, to prevent loosening and noise. Also, during each assembly step, ensure that ALL nuts and bolts are in place and partially threaded in before completely tightening any ONE bolt.