



# *Owner's Guide*

**E3000, E4000, E3100, E3200 & E3200HRT  
UPRIGHT FITNESS CYCLES**

---







**C**ongratulations on choosing a VISION FITNESS Bike. You've taken an important step in developing and sustaining an exercise program! Your Bike is a tremendously effective tool for achieving your personal fitness goals. Regular use of your Bike can improve the quality of your life in so many ways...

Here are just a few of the health benefits of aerobic exercise:

- Weight Loss
- A Healthier Heart
- Improved Muscle Tone
- Increased Daily Energy Levels
- Reduced Stress
- Help In Countering Anxiety and Depression
- An Improved Self Image

The key to reaping these benefits is to develop the exercise habit. Your new Bike will help you eliminate the obstacles that prevent you from getting in your exercise time. Snow and rain and darkness won't interfere with your workout when you have your Bike in the comfort of your home. This Owner's Guide provides you with basic information on starting an exercise program. A more complete knowledge of your new Bike will assist you in realizing your goal of a healthy lifestyle.

Some kinds of service to your Bike should only be performed by your VISION FITNESS retailer. Please contact your authorized VISION FITNESS retailer should service be required. If a question or problem arises which cannot be handled by your VISION FITNESS retailer, please contact us:

VISION FITNESS  
P.O. Box 280  
621-D East Lake St.  
Lake Mills, WI 53551  
Ph: 1.800.335.4348  
Fax: 1.920.648.3373  
[www.visionfitness.com](http://www.visionfitness.com)

# Table of Contents

ALL MODELS

E3000

E4000

E3100

E3200

E3200HRT

GENERAL

## ALL MODELS

SAFETY INSTRUCTIONS	4
ASSEMBLY, MOVING, PLACEMENT	6
SEAT ADJUSTMENTS	7

## E3000

### E4000 CONSOLE

BATTERIES, TURNING ON	8
COUNTDOWN, COUNTUP, OFF	9
RESISTANCE, RESETTING	10
FEEDBACK DISPLAY	11
DUAL-ACTION BENEFITS	11

### E3100 CONSOLE

BATTERIES, TURNING ON	12
SETTING MPH/KPH	13
COUNTDOWN, COUNTUP, START	14
CHOOSING WEIGHT, RESISTANCE	15
PAUSE, RESET	16
FEEDBACK DISPLAY	17

### E3200 CONSOLE

SETTING MPH/KPH	18
STARTING IN MANUAL MODE	19
PROGRAM DETAILS	20
FEEDBACK DISPLAY	21
SETTING WEIGHT DEFAULT	22
PROGRAM, LEVEL, TIME	23
RACE PROGRAM	24

## E3200HRT CONSOLE

SETTING MPH/KPH	26
STARTING IN MANUAL MODE	27
PROGRAM DETAILS	28
FEEDBACK DISPLAY	29
SETTING WEIGHT DEFAULT	30
PROGRAM, LEVEL, TIME	31
USING HRT PROGRAM	32
USING HEART RATE STRAP	33

## GENERAL

TROUBLESHOOTING:	
BIKES	34
HEART RATE MONITOR	35
COMMON QUESTIONS	
HOME WARRANTY	38
LIGHT COMMERCIAL WARRANTY (E4000, E3100, E3200 & E3200HRT)	40
FITNESS GUIDELINES	42
TARGET HEART RATE	46
RATE OF PERCEIVED EXERTION	47
WEEKLY WORKOUT LOGS	50
MONTHLY WORKOUT LOGS	52

E4000

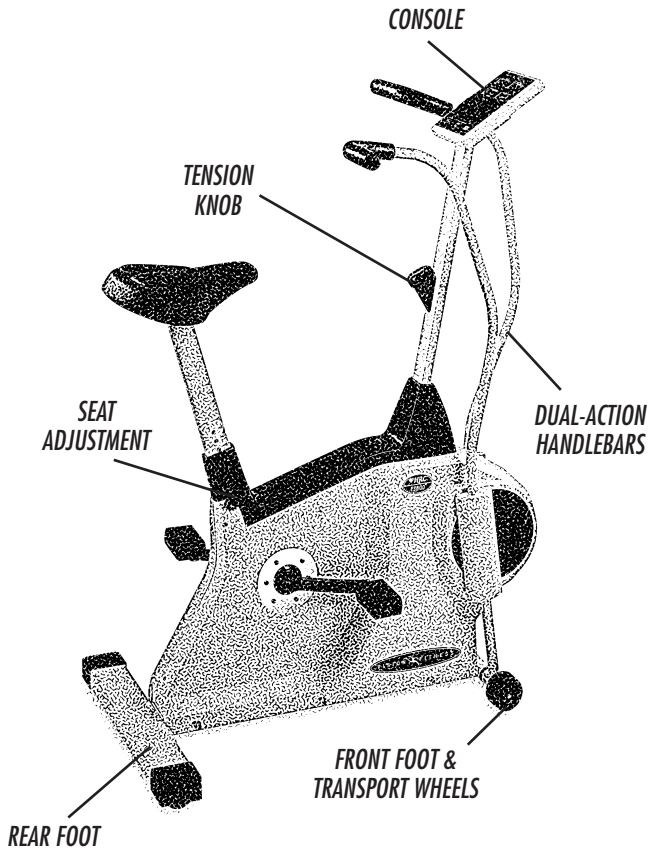

2

**E 4 0 0 0**

DUAL-ACTION UPRIGHT FITNESS CYCLE

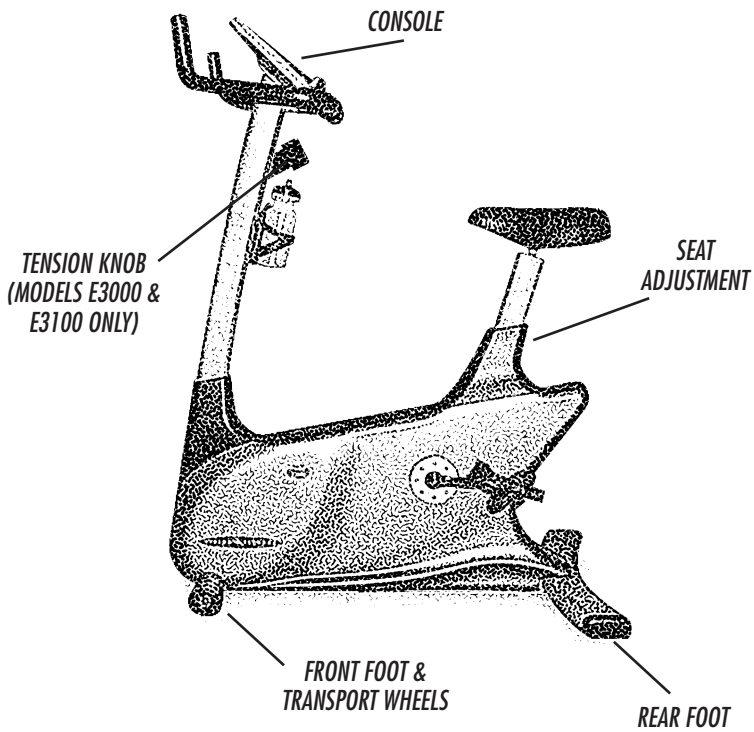

E3000

E3100

E3200

E3200HRT

**E3000**

**E3100**

**E3200**

**E3200HRT**

UPRIGHT FITNESS CYCLES

# IMPORTANT SAFETY INSTRUCTIONS

## SAVE THESE INSTRUCTIONS

When using an electrical product, basic precautions should always be followed, including the following:

Read all instructions before using this exercise product.

**WARNING!** To reduce the risk of burns, fire, electrical shock or injury to persons:

- Use this exercise product for its intended use as described in this Owner's Guide. Do not use attachments not recommended by the manufacturer.
- Never drop or insert any object into any opening.
- Do not remove the Bike sidecovers. Service should be performed only by an authorized VISION FITNESS retailer.

Models *E3200* & *E3200HRT* only:

- Never operate this Bike if it has a damaged cord or plug, if it is not working properly, if it has been damaged, or immersed in water. Return the Bike to a retailer for examination and repair.
- Keep the cord away from heated surfaces.
- Do not use outdoors.
- To disconnect, turn the switch to the OFF position, then remove plug from outlet.
- Only use the power cord provided with your VISION FITNESS Bike.
- Never place the power cord under carpeting or place any object on top of the power cord, which may pinch and damage it.
- Unplug your Bike before moving it.

### CHILDREN

- Keep children off your Bike at all times.
- When the Bike is in use, young children and pets should be kept at least 10 feet away.



## OTHER SAFETY TIPS FOR YOUR VISION FITNESS BIKE

**CAUTION!** If you experience chest pains, nausea, dizziness or shortness of breath, stop exercising immediately and consult your physician before continuing.

- Do not wear loose clothing that might catch on any part of the Bike.
- Read this Owner's Guide before operating this Bike.

## CLEANING

- Clean with soap and slightly damp cloth only; never use solvents.

## ASSEMBLY

If you have elected to assemble this product yourself, for your safety please read and follow each of the steps in the enclosed assembly instructions. It is recommended, when possible, that assembly be performed by an authorized VISION FITNESS retailer. If you have any questions regarding any part or function of your Bike, contact your retailer.

## MOVING

Your VISION FITNESS Bike has a pair of transport wheels built into the front legs. To move your upright Bike, firmly grasp the handlebars, carefully tip toward you and roll on the transport wheels.

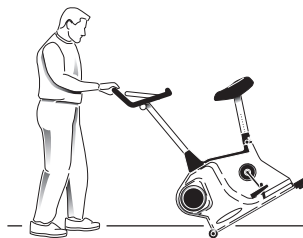

**CAUTION:** Our Bikes are well-built and heavy, weighing up to 140 lbs.! Use care and additional help if necessary.

## PLACEMENT IN YOUR HOME

It is important that you place your Bike in a comfortable and inviting room. Your Bike is designed to use minimal floor space. Many people will place their Bike facing the TV or a picture window. If at all possible, avoid putting your Bike in an unfinished basement. To make exercise a desirable daily activity for you, the Bike should be in an attractive setting.

## LEVELING

The Bike should be level for optimum use. If your Bike wobbles when you have placed it where you intend to use it, raise or lower one or both of the adjustable levelers located on the bottom of the rear foot support. Once you have leveled the Bike, lock the levelers in place by tightening the wing nuts against the rear foot support.

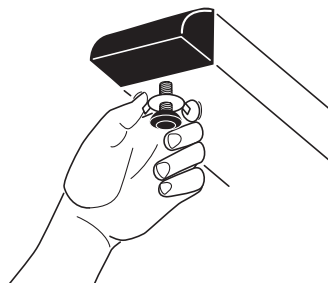

## SEAT ADJUSTMENT

Grasp the Seat Adjustment Knob, located at the base of the seatpost. Pull the Knob out, then raise or lower the seatpost to the desired height. Release the Knob and allow the seatpost to lock into position.

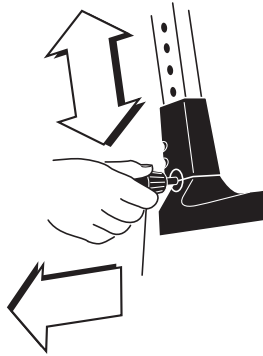

## SEAT POSITIONING

The seat is at the proper position when your knee is slightly bent when the pedal is in the furthest position, with the ball of your foot centered on the pedal.



## CONSOLE

Your easy-to-use VISION FITNESS Manual computer console provides the information you need to monitor your progress toward your personal fitness goals.

### INSTALLING BATTERIES

If your Bike batteries have not already been installed by your retailer, please install them now. Your Manual console uses two size AA batteries. These batteries are located in a snap-open battery compartment in the back of the console.

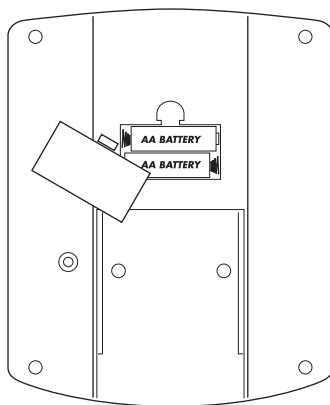

### TURNING SCREEN DISPLAY ON

To turn the screen display on, press any console button or turn the pedals one complete revolution. When the display first comes on, '0:00' will be flashing in the TIME window.

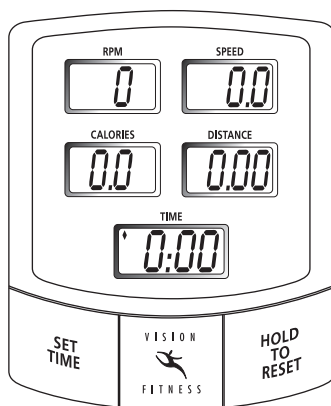

## CHOOSING TIME AND STARTING

There are two ways to use the timer: Count-Down Mode or Count-Up Mode.

### COUNT-DOWN MODE

Press the SET TIME button to enter your workout time. When the time you choose is showing in the TIME window, start pedaling. The timer will begin counting down to zero. When the workout time is completed, the console will beep for 5 seconds, then begin counting-up if you continue pedaling. To reset, press and hold the HOLD TO RESET button.

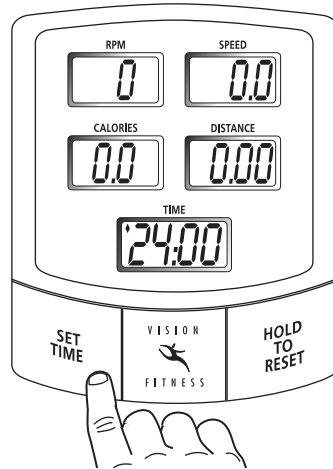

### COUNT-UP MODE

To use the timer in count up mode, simply start pedaling when '0:00' is flashing on the screen.

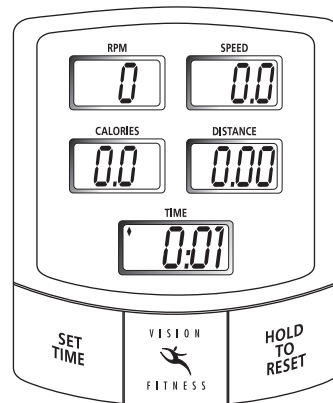

### TURNING SCREEN DISPLAY OFF

The screen display will go off automatically after 5 minutes of non-use.

## CHANGING RESISTANCE

There are two ways to increase your workload. You can pedal faster, or you can turn the tension knob which is located below the console. The tension knob will adjust to one of 15 levels of resistance.



## PARTIAL RESET

To reset Time only, touch the HOLD TO RESET button. Time will return to '0:00' and not delete the values in the other windows.

## FULL RESET

To reset all the console values, press and hold the HOLD TO RESET button. Time will return to '0:00' then all the other values will be deleted.

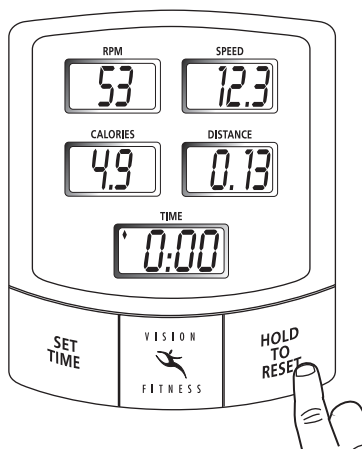

## FEEDBACK DISPLAY

### RPM

Shown as Revolutions-per-Minute. Improve cycling technique while reducing leg muscle fatigue by pedaling between 80 and 100 RPMs.

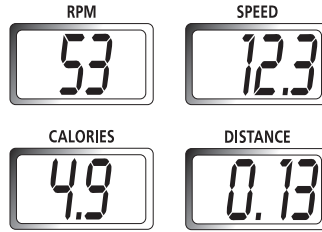

### SPEED

Shown as Miles-per-Hour. View your current pedaling speed.

### CALORIES

Shown as estimated total Calories burned during workout.

### DISTANCE

Set personal goals for covering greater amounts of distance for each program. You can log mileage as a motivational tool.

### TIME

Shown as Minutes:Seconds. View the time remaining if the Count-Down mode is used, or view the elapsed time if the Count-Up mode is used.



## BENEFITS OF THE E4000 DUAL-ACTION BIKE

By combining upper and lower body exercises in one machine, you get total body benefits from every workout. Because you are exercising all the major upper and lower body muscle groups you can achieve better results in less time.

The E4000 is also a great choice for rehabilitation patients. The dual-action design lets you use either upper-body or lower-body to produce most of the work, while helping to strengthen or increase range of motion to the other.

## CONSOLE

Your easy-to-use VISION FITNESS E3100 computer console provides the information you need to monitor your progress toward your personal fitness goals.

## INSTALLING BATTERIES

If your batteries have not already been installed by your retailer, please install them now. Your E3100 console uses two size AA batteries. These batteries are located inside the mounting recess in the back of the console.

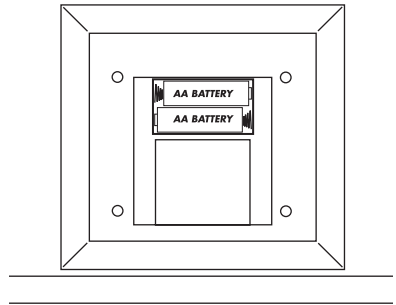

## TURNING SCREEN DISPLAY ON

To turn the screen display on, press any console button or turn the pedals one complete revolution. When the display first comes on, '0:00' will be flashing in the TIME window.

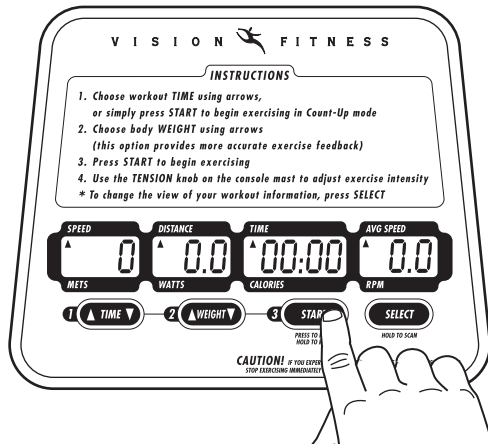



## SETTING MPH & KPH

Your *E3100* console should be set to Miles when you receive it. If it is not set to Miles or if you would like to change the feedback to Kilometers do the following steps.

- Take out the batteries.
- Reinsert the batteries – this will bring you to setup mode which will last for 30 seconds.
- You will hear a series of beeps and the model of the product will appear in the TIME window.
- The option “ML” for MILES or “KL” for KILOMETERS will also appear in the TIME window.
- Press the SELECT button to go to the appropriate distance setting.
- When you have the desired distance setting, press and hold the START button until you hear the beep.

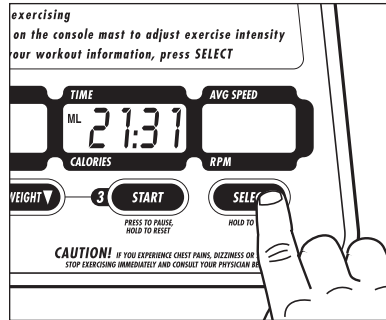

## CHOOSING TIME AND STARTING

There are two ways to use the timer: Count-Down Mode and Count-Up Mode.

### COUNT-DOWN MODE

Press the TIME ▲ or ▼ button to enter your workout time. When the Time you choose is showing in the TIME window, move to the WEIGHT button. To reset the Time, press and hold the START button for about three seconds.

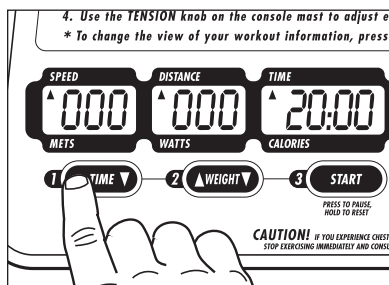

### COUNT-UP MODE

To use the timer in count-up mode, simply set WEIGHT, press START and begin; or press START to begin.

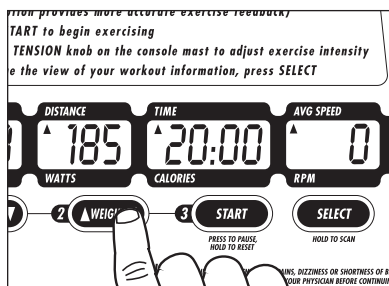

## CHOOSING WEIGHT

After deciding on workout time, press the WEIGHT ▲ or ▼ button. The default Weight of 150 pounds will flash in the second window. Continue to set the appropriate Weight. Press START and begin exercising.

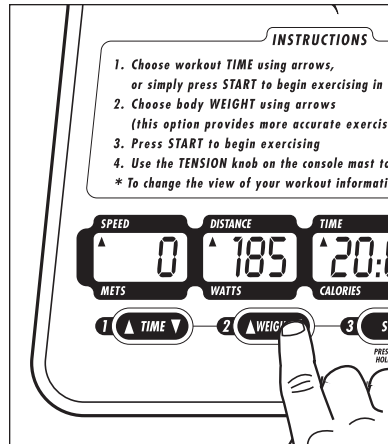

## CHANGING RESISTANCE

There are two ways to increase your workload. You can pedal faster, or you can turn the tension knob which is located below the console. The tension knob will adjust to one of 16 levels of resistance.

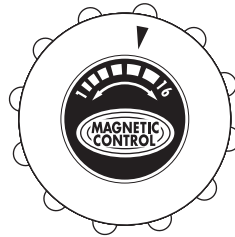

## PAUSE

You can pause your program for 30 seconds. Simply press the START button while you are pedaling and the time will stop counting. Resume the time counting by pressing the START button a second time. If you do not resume the time within 30 seconds, it will reset to '0:00'.

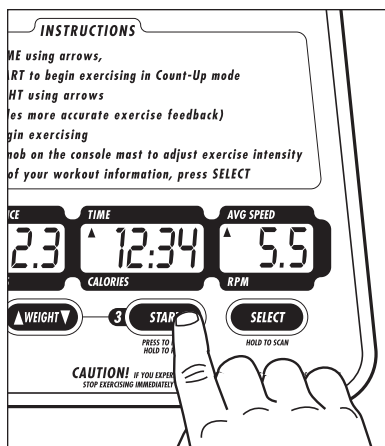

## FULL RESET

To reset the console, press and hold the START button. The TIME will return to '0:00' and all of the other values will also return to zero.

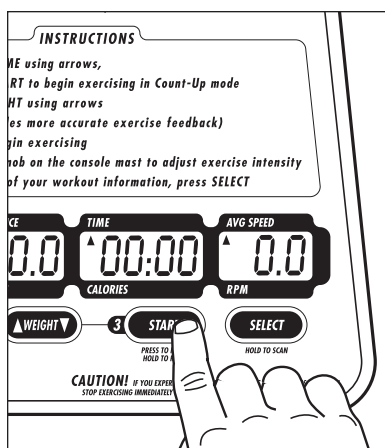

## FEEDBACK DISPLAY



Use the SELECT button to change the readout of the feedback information. The SPEED, DISTANCE, TIME and AVG SPEED feedback will be displayed. To view the METS, WATTS, CALORIES, and RPM feedback press the SELECT button. To scan through all feedback, press and hold the SELECT button for 3 seconds.

### SPEED

Shown as Miles-per-Hour. View your current pedaling speed.

### DISTANCE

Set personal goals for covered distance. You can log mileage as a motivational tool.

### TIME

Shown as Minutes:Seconds. View the time remaining if the Count-Down mode is used, or view the elapsed time if the Count-Up mode is used.

### AVERAGE SPEED

Shown as Miles -per-Hour. Equals accumulated Distance ÷ elapsed Time. Corresponds to simulated outdoor biking Speed.

### METS

The amount of energy you are expending. One MET equals 3.5ml Oxygen-per-Kilogram-per Minute.

### WATTS

A measurement of work performed. May be used to evaluate and quantify your fitness progress over time.

### CALORIES

Shown as estimated total Calories burned during workout.

### RPM

Shown as Revolutions-per-Minute. Improve pedaling technique while reducing leg muscle fatigue by pedaling between 80 and 100 RPMs.

## SETTING MPH & KPH

Your *E3200* Console arrives preset to display Miles. If you wish to display Kilometers instead, remove the Console from the Console Mast by removing the four mounting bolts. Inside the mounting recess you will find a small switch; move this Kilometers/Miles Conversion Switch to the left to display Kilometers. Remount the Console to the Console Mast.

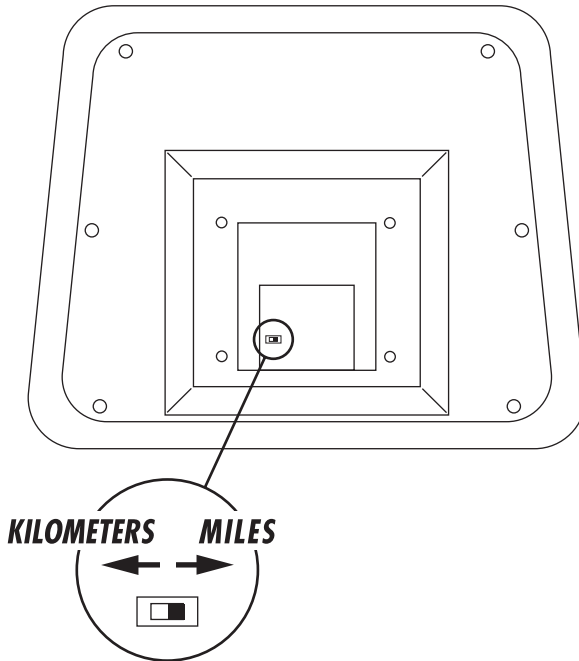

## DISPLAY

Simply press the START button to begin exercising in the MANUAL Program.

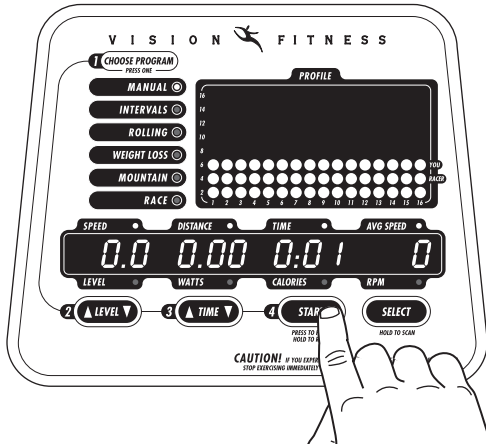

## PROGRAM DETAILS

**MANUAL** ⦿ Customize your workout; no default Time.

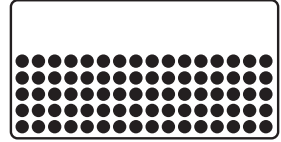

**INTERVALS** ⦿ Improves your maximum aerobic capacity by alternating performance intervals and recovery intervals. A great workout that produces results and saves time; Time defaults to 24 minutes.

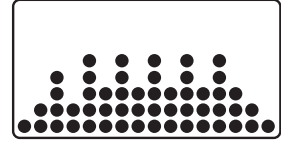

**ROLLING** ⦿ Simulates rolling hills by gradually raising and lowering resistance. Ideal for weight maintenance; Time defaults to 32 minutes.

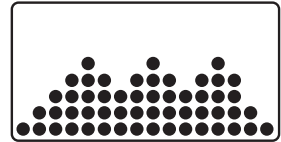

**WEIGHT LOSS** ⦿ Promotes weight loss by raising and lowering resistance slightly to keep your heart in a fat-burning zone; Time defaults to 48 minutes.

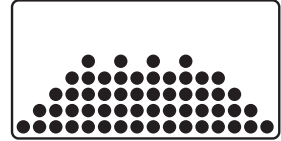

**MOUNTAIN** ⦿ Simulates a gradual climb up a mountain and a quick descent for the cool-down. Great for building leg strength and increasing your cardiovascular system; Time defaults to 24 minutes.

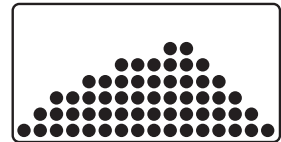

**RACE** ⦿ Compete with the RACER across the profile screen. A challenging workout that helps improve cycling performance; Time defaults to 24 minutes.

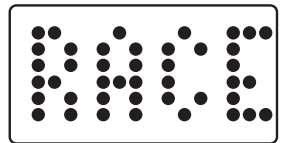

All programs have 16 levels of resistance. Low-end resistance begins at Level 1 and increases to the high-end resistance of 16.



## FEEDBACK DISPLAY



Use the SELECT button to change the readout of the feedback information. The SPEED, DISTANCE, TIME and AVG SPEED feedback will be displayed. To view the LEVEL, WATTS, CALORIES, and RPMS feedback press the SELECT button. To scan through all feedback, press and hold the SELECT button for 3 seconds.

### SPEED

Shown as Miles-per-Hour or Kilometers-per-Hour. View the current cycling Speed.

### DISTANCE

Shown as Miles or Kilometers. View Distance during workout.

### TIME

Shown as Minutes:Seconds. View the Time remaining or the Time elapsed in your workout.

### AVERAGE SPEED

Shown as Miles-per-Hour. Equals accumulated Distance  $\div$  elapsed Time. Corresponds to simulated outdoor biking Speed.

### FINISHING

When your work-out is complete the Display windows will begin flashing your workout information, allowing you to record it in your personal logbook.

### PROGRAM LEVEL

View the current chosen Program Level. Indicates the difficulty of your workout, with L1 being the easiest and L16 being the most difficult.

### WATTS

A measurement of your expended energy. May be used to evaluate and quantify your fitness progress over time.

### CALORIES

Shown as estimated total Calories burned during workout.

### RPM

Shown as Revolutions-per-Minute. Improve cycling technique while reducing leg muscle fatigue by pedaling between 80 & 100 RPMs.

## CHANGING THE DEFAULT FOR WEIGHT

Since some E3200 Bikes are used in the home setting, VISION FITNESS has included the option of changing the default weight to achieve a more accurate estimate of Calorie feedback. The default Weight feature allows the user to set the default Weight that most closely relates to its users.

Hold the LEVEL ▼ and the TIME ▲ buttons for 10 seconds. "En91" will appear.

Press the LEVEL ▲ button until you reach "En95".

Press SELECT. The default Weight will appear in the WATTS window.

To adjust the default Weight, use either set of ▲ / ▼ buttons. To set the new default Weight, press and hold the SELECT button for three seconds.

Press and hold START for three seconds to exit out of "En95". Press and hold START for three seconds to exit out of the Eng mode.

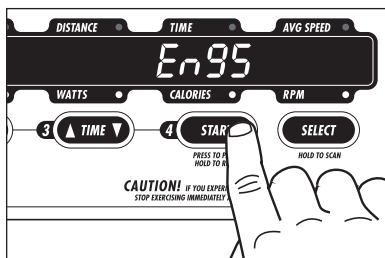
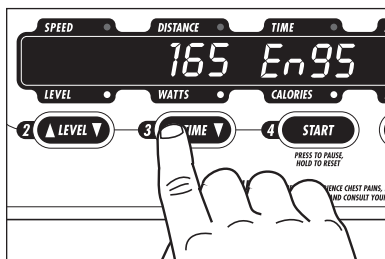
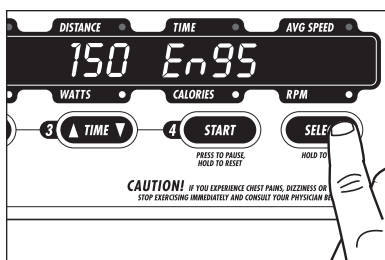
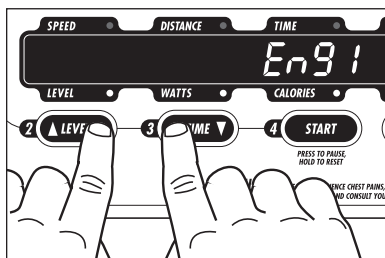

## CHOOSING A PROGRAM

If you do not choose a Program, the console will default to the MANUAL Program. If you wish to choose another Program, simply press one of the other Program buttons.

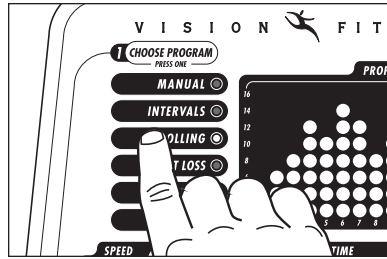

## CHOOSING A LEVEL

After you have chosen a Program, the Level will default to L6 and then flash. You may use this default level or choose another by using the LEVEL ▲ or ▼ button; L1 provides the least resistance, L16 the most.

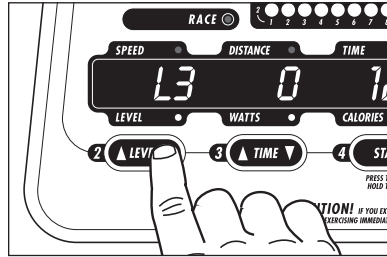

## CHOOSING A TIME

After you have chosen a Level, the Time will default, depending on which Program you have chosen, and then flash. You may use this default Time or choose another by using the TIME ▲ or ▼ button.

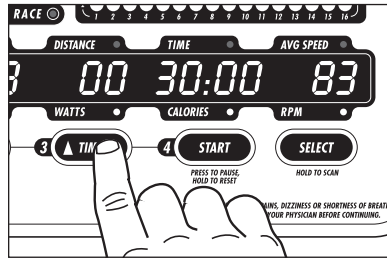

## STARTING

When you are ready to begin exercising press START.

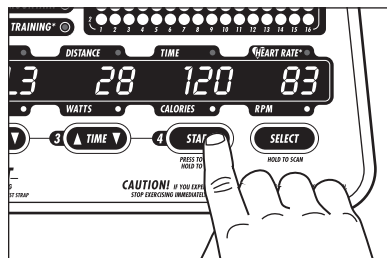

## USING YOUR BIKE'S RACE PROGRAM

The RACE Program is exclusive to the *E3200* console. It is a challenging program that simulates an outdoor bike race. You determine the speed of the "Racer" by selecting the LEVEL when you start the program. The speed of the "Racer" at level 1 is 12 MPH. The speed will increase by 1 MPH for each increase in LEVEL. Simply adjust your pedal RPM or change gears by using the LEVEL button to exceed that pace throughout the program. A solid row of lights will show in the "Racer" column and the "You" column. If you beat the "Racer" the message "WIN" will appear on your screen. Note that the entire time goal will not have elapsed. If the "Racer" beats you, the entire race time will elapse.

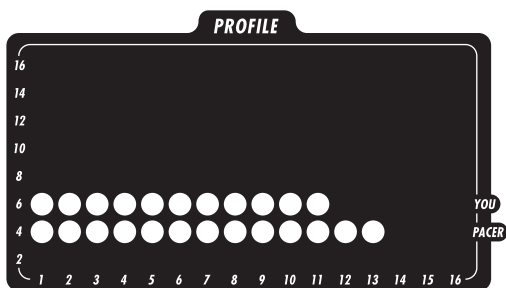



## SETTING MPH & KPH

Your *E3200HRT* Console arrives preset to display Miles. If you wish to display Kilometers instead, remove the Console from the Console Mast by removing the four mounting bolts. Inside the mounting recess you will find a small switch; move this Kilometers/Miles Conversion Switch to the left to display Kilometers. Remount the Console to the Console Mast.

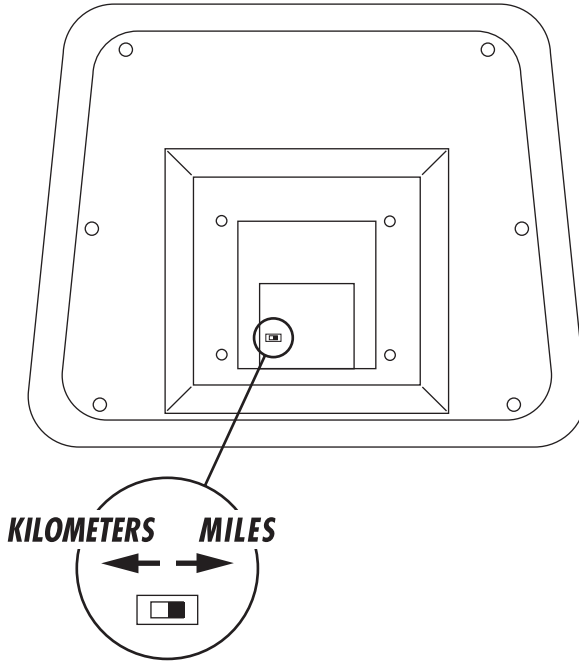

# DISPLAY

Simply press the START button to begin exercising in the MANUAL Program.

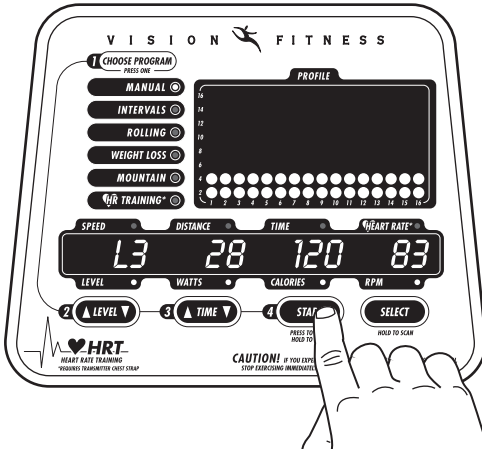

## PROGRAM DETAILS

**MANUAL** Ⓞ Customize your workout; no default Time.

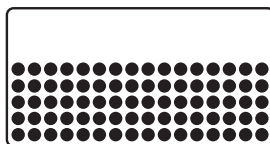

**INTERVALS** Ⓞ Improves your maximum aerobic capacity by alternating performance intervals and recovery intervals. A great workout that produces results and saves time; Time defaults to 24 minutes.

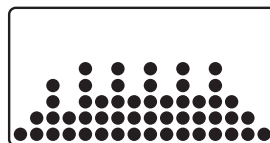

**ROLLING** Ⓞ Simulates rolling hills by gradually raising and lowering resistance. Ideal for weight maintenance; Time defaults to 32 minutes.

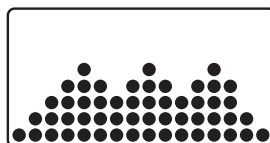

**WEIGHT LOSS** Ⓞ Promotes weight loss by raising and lowering resistance slightly to keep your heart in a fat-burning zone; Time defaults to 48 minutes.

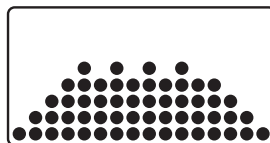

**MOUNTAIN** Ⓞ Simulates a gradual climb up a mountain and a quick descent for the cool-down. Great for building leg strength and increasing your cardiovascular system; Time defaults to 24 minutes.

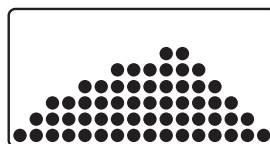

**HR TRAINING\*** Ⓞ Set your Target Heart Rate and let the program adjust from there. The intensity will adjust to keep you in your Training Zone. A great way to optimize your exercise intensity; Time defaults to 24 minutes.



All programs have 16 levels of resistance. Low-end resistance begins at Level 1 and increases to the high-end resistance of 16.



## FEEDBACK DISPLAY



Use the SELECT button to change the readout of the feedback information. The SPEED, DISTANCE, TIME and HEART RATE feedback will be displayed. To view the LEVEL, WATTS, CALORIES, and RPMS feedback press the SELECT button. To scan through all feedback, press and hold the SELECT button for 3 seconds.

### SPEED

Shown as Miles-per-Hour or Kilometers-per-Hour. View the current cycling Speed.

### DISTANCE

Shown as Miles or Kilometers. View Distance during workout.

### TIME

Shown as Minutes:Seconds. View the Time remaining or the Time elapsed in your workout.

### HEART RATE

Shown as Beats per Minute. You can monitor your Heart Rate at any time during a workout.

### FINISHING

When your work-out is complete the Display windows will begin flashing your workout information, allowing you to record it in your personal logbook.

### PROGRAM LEVEL

View the current chosen Program Level. Indicates the difficulty of your workout, with L1 being the easiest and L16 being the most difficult.

### WATTS

A measurement of your expended energy. May be used to evaluate and quantify your fitness progress over time.

### CALORIES

Shown as estimated total Calories burned during workout.

### RPM

Shown as Revolutions-per-Minute. Improve cycling technique while reducing leg muscle fatigue by pedaling between 80 & 100 RPMs.

## CHANGING THE DEFAULT FOR WEIGHT

Since some *E3200HRT* Bikes are used in the home setting, VISION FITNESS has included the option of changing the default weight to achieve a more accurate estimate of Calorie feedback. The default Weight feature allows the user to set the default Weight that most closely relates to its users.

Hold the LEVEL ▼ and the TIME ▲ buttons for 10 seconds. "En91" will appear.

Press the LEVEL ▲ button until you reach "En95".

Press SELECT. The default Weight will appear in the WATTS window.

To adjust the default Weight, use either set of ▲ / ▼ buttons. To set the new default Weight, press and hold the SELECT button for three seconds.

Press and hold START for three seconds to exit out of "En95". Press and hold START for three seconds to exit out of the Eng mode.

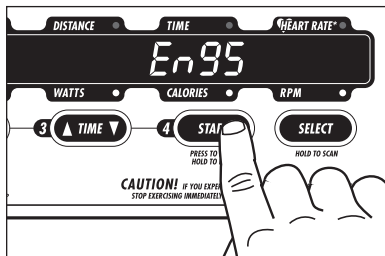
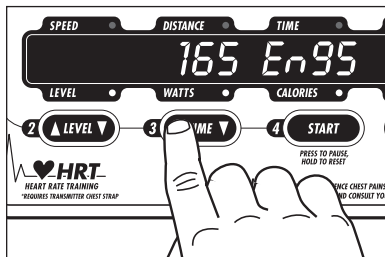
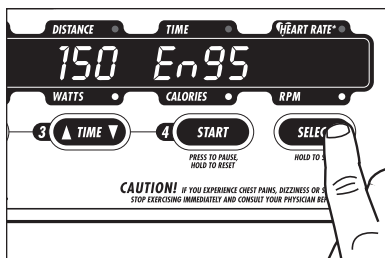
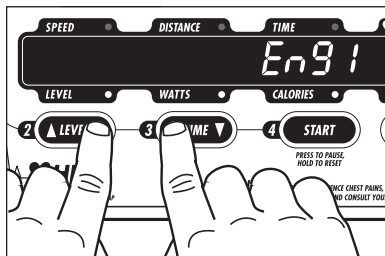

## CHOOSING A PROGRAM

If you do not choose a Program, the console will default to the MANUAL Program. If you wish to choose another Program, simply press one of the other Program buttons.

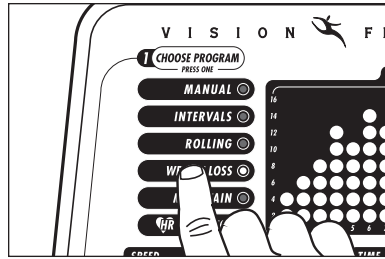

## CHOOSING A LEVEL

After you have chosen a Program, the Level will default to L6 and then flash. You may use this default level or choose another by using the LEVEL ▲ or ▼ button; L1 provides the least resistance, L16 the most.

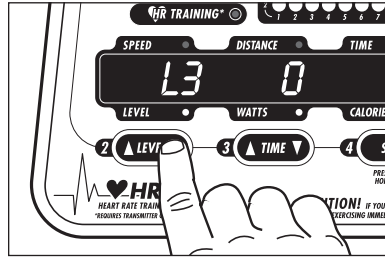

## CHOOSING A TIME

After you have chosen a Level, the Time will default, depending on which Program you have chosen, and then flash. You may use this default Time or choose another by using the TIME ▲ or ▼ button.

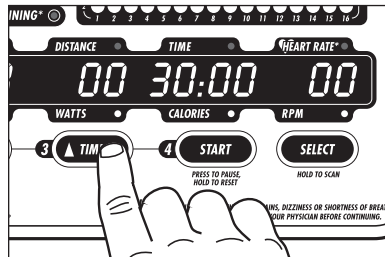

## STARTING

When you are ready to begin exercising press START.

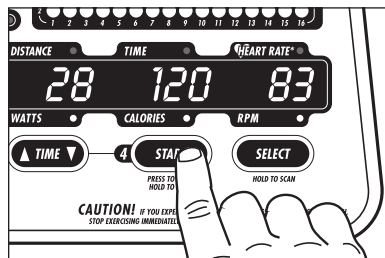

## USING YOUR BIKE'S HRT PROGRAM

Use the chart on Page 46 to determine your Target Heart Rate, then follow the instructions on Page 33 to place the wireless transmitter on your chest.

Choose the Heart Rate Program by pressing the ♥HR TRAINING button.

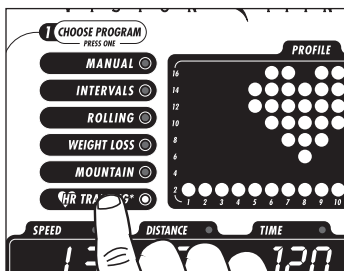

Using the LEVEL ▲ or ▼ button, select your Target Heart Rate, visible in the LEVEL window.

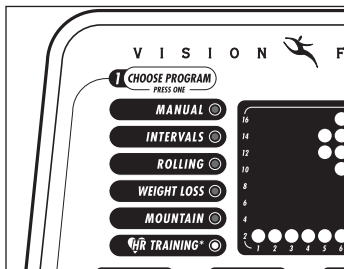

Using the TIME ▲ or ▼ button, select your Time, or you may use the default time of 24 Minutes.

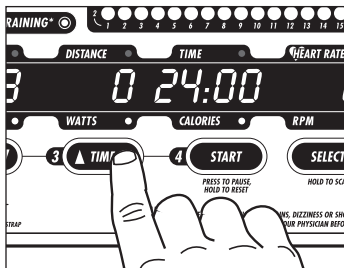

When you are ready to begin exercising press START.

The Bike will take you through a brief warm-up period for the first 25% of your total workout Time, and then it will begin to raise the resistance until your Heart Rate is within +/-5 Beats per Minute of the Target Heart Rate you entered. During the final 12% of your workout Time, the Bike will begin your cool-down period and lower the resistance.

## WIRELESS CHEST TRANSMITTER

Prior to wearing the Strap on your chest, moisten the two rubber contact pads with several drops of water and spread about with your fingers.

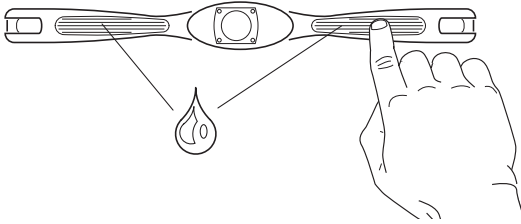

## TRANSMITTER STRAP PLACEMENT

Center the Transmitter Strap just below the breast or pectoral muscles, directly over your sternum with the VISION FITNESS logo facing out.

Adjust the elastic strap length to avoid bouncing or sliding.

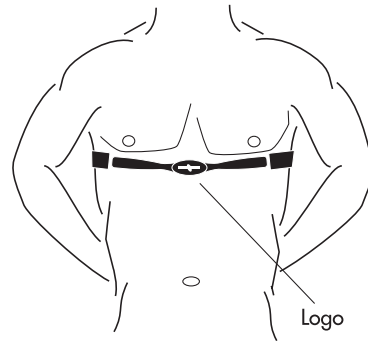

## TROUBLESHOOTING YOUR FITNESS BIKE

Our Bikes are designed to be reliable and easy to use. If, however, you have a problem, these troubleshooting steps may indicate the cause.

**PROBLEM:** The Console does not light up.

**SOLUTION:** 1) Check to make sure the Bike is turned on (switch is located near power supply).

**PROBLEM:** The Bike is making a clicking noise.

**SOLUTION:** Using the supplied 15<sup>MM</sup> wrench, remove both the right and left pedals, apply grease to the threaded portion of the pedals and reassemble the unit, making sure the pedals are as tight as possible.

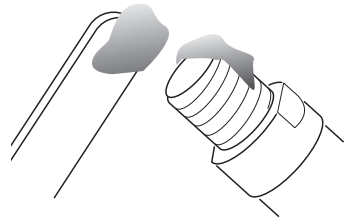

**PROBLEM:** The Bike appears to work but there is no resistance change.

**SOLUTION:** The magnetic brake assembly is not working properly; please contact your retailer.

**PROBLEM:** The Bike makes a squeaking or creaking noise.

**SOLUTION:** Check and tighten all the bolts on the Bike again.

**NOTE:** If the above steps do not remedy the problem, discontinue use, turn the power off and contact your retailer.

## TROUBLESHOOTING YOUR HEART RATE MONITOR CHEST STRAP

**PROBLEM:** No pulse reading appears

**SOLUTION:** There may be a poor connection between the contact pads and skin. Remoisten electrodes.

**SOLUTION:** Transmitter is not properly positioned. Reposition the chest strap.

**SOLUTION:** Verify that the distance between transmitter and receiver is not beyond the recommended range of 36 inches.

**PROBLEM:** There is an erratic pulse rate.

**SOLUTION:** Chest strap is too loose; readjust according to directions.

**NOTE:** It is possible that heart rate monitors will not function properly on some people due to a variety of reasons. It may be necessary to experiment with the fit and position of the chest strap. Outside interference sources such as computers, motors, etc. are also a major source of problems for heart rate monitors.

## COMMON BIKE QUESTIONS

Q: Are the sounds my Bike makes normal?

A: Our Bikes are some of the quietest available because they use belt drives and magnetic resistance. We use the highest grade European bearings and top quality belts to minimize noise. However, because the resistance system itself is so quiet, you will occasionally hear some slight mechanical noises from the drive train. Unlike older, louder technologies, there are no fans, friction belts, or alternator noises to mask these sounds on our Bikes. These mechanical noises, which may or may not be intermittent, are normal and are caused by the transfer of significant amounts of energy to a rapidly spinning flywheel. All bearings, belts and other rotating parts will generate some noise which will transmit through the casing and frame. It is also normal for these sounds to change slightly during a workout, and over time, because of thermal expansion of the parts. Keep in mind that while you work out you're sometimes exerting the equivalent mechanical energy of a washing machine or dryer!

Q: Why is the Bike I had delivered louder than the one at the store?

A: All fitness products seem quieter in a large store showroom because there is generally more background noise than in your home. Also, there will be less reverberation on a carpeted concrete floor than on a wood overlay floor. Sometimes a heavy rubber mat will help reduce reverberation through the floor. And finally, if a fitness product is placed close to a wall, there will be more reflected noise.

Q: When should I be worried about a noise?

A: As long as the sounds your Bike makes are no louder than a normal conversational tone of voice, it is considered normal noise. If your Bike is louder than this, you may want to call your service technician. Sometimes an initial diagnosis can be made over the phone.



Q: What kind of routine maintenance is required?

A: We use sealed bearings throughout our Bikes so lubrication is not needed. The most important maintenance step is to simply wipe your perspiration off the Bike after each use.

Q: Will the magnets wear out over time?

A: No, we use permanent magnets that will retain their braking force indefinitely in this application. One of the big advantages of a magnetic brake is its long life since there is no physical contact between the flywheel and the magnet surface.

Q: How long will the drive belt last?

A: The computer modeling we had done indicated virtually thousands of maintenance-free hours. These belts are now used in far more demanding applications such as motorcycle drives.

## LIMITED HOME USE WARRANTY

VISION FITNESS extends the following exclusive, limited warranty, which shall apply only to the use of the device in the home, for residential, non-commercial purposes only. Any other use of the device shall void this warranty.

VISION FITNESS hereby extends the following limited warranties for the following components of the device, for the time period indicated:

**FRAME - LIFETIME** VISION FITNESS warrants the Frame against defects in workmanship and materials for the life of the product, so long as it remains in the possession of the original owner.

**ECB-PLUS™ BRAKE - LIFETIME** VISION FITNESS warrants the ECB-PLUS™ Magnetic Brake against defects in workmanship and materials for the life of the product, so long as it remains in the possession of the original owner. Only the Brake and Magnet assembly, and no other ancillary components or parts, are covered by this lifetime warranty

**ELECTRONICS & PARTS - TWO YEARS** VISION FITNESS warrants the Electronic components and all original Parts (other than the ECB-PLUS™ Magnetic Brake) against defects in workmanship and materials for a period of two years from the date of original purchase, so long as the device remains in the possession of the original owner.

**LABOR - ONE YEAR** VISION FITNESS shall cover the Labor cost for the repair of the device for a period of one year from the date of original purchase, so long as the device remains in the possession of the original owner.

## LIMITED HOME USE WARRANTY (continued)

### EXCLUSIVE REMEDY

The exclusive remedy for any of the above warranties shall be repair or replacement of defective Parts, or the supply of Labor to cure any defect, provided that Labor shall be limited to one year. All Labor shall be supplied by the local Retailer who sold the Product, and the Product must be located within that Retailer's service area. Products located outside the Retailer's service area will not be covered by the Labor warranty.

### EXCLUSIONS AND LIMITATIONS

This warranty applies only to the original owner and is not transferable. This warranty is expressly limited to the repair or replacement of a defective Frame, ECB-PLUS™ Magnetic Brake, Electronic component, or defective Part and is the sole remedy of the warranty. The warranty does not cover normal wear and tear, improper assembly or maintenance, or installation of parts or accessories not originally intended or compatible with the Fitness Product as sold. The warranty does not apply to damage or failure due to accident, abuse, corrosion, discoloration of paint or plastic, or neglect. VISION FITNESS shall not be responsible for incidental or consequential damages. Parts and Electronic components reconditioned to As New Condition by VISION FITNESS or its vendors may sometimes be supplied as warranty replacement parts and constitute fulfillment of warranty terms. Any warranty replacement parts shall be warranted for the remainder of the original warranty term.

VISION FITNESS expressly disclaims all other warranties, express or implied, including but not limited to all warranties of fitness for a particular purpose or of merchantability. This warranty gives you specific legal rights and your rights may vary from state to state.

### WARRANTY REGISTRATION

Your warranty card must be completed and sent to VISION FITNESS before a warranty claim can be processed. You may also register via our website at [www.visionfitness.com](http://www.visionfitness.com). Inside the enclosed warranty card you will find a customer survey. Your care in completing the survey will be of value to us in serving you in the future. Comments and suggestions are always welcome. We are certain you will enjoy your new Bike. Thank you for selecting a VISION FITNESS product.

## LIMITED LIGHT COMMERCIAL WARRANTY

Up to 3 hours use per day

**LIGHT COMMERCIAL USES DEFINED** VISION FITNESS warrants models E4000, E3100, E3200 & E3200HRT for use in light commercial facilities including: Hotels, Resorts, Police & Fire Stations, Apartment Complexes, Corporate Fitness Centers, Hospitals, Rehabilitation and Sports Medicine Clinics, where average use is up to three hours per day. Not warranted for private Health Clubs, YMCA's or Schools.

**FRAME, ECB-PLUS™ BRAKE, ELECTRONICS & PARTS - ONE YEAR** VISION FITNESS warrants the Frame, ECB-PLUS™ Magnetic Brake, Electronic components and all original Parts against defects in workmanship and materials for a period of one year from the date of original purchase, so long as the device remains in the possession of the original owner.

**LABOR - ONE YEAR** VISION FITNESS shall cover the Labor cost for the repair of the device for a period of one year from the date of original purchase, so long as the device remains in the possession of the original owner.

### EXCLUSIVE REMEDY

The exclusive remedy for any of the above warranties shall be repair or replacement of defective Parts, or the supply of Labor to cure any defect, provided that Labor shall be limited to one year. All Labor shall be supplied by the local Retailer who sold the Product, and the Product must be located within that Retailer's service area. Products located outside the Retailer's service area will not be covered by the Labor warranty.

## LIMITED LIGHT COMMERCIAL WARRANTY (continued)

Up to 3 hours use per day

### EXCLUSIONS AND LIMITATIONS

This warranty applies only to the original owner and is not transferable. This warranty is expressly limited to the repair or replacement of a defective Frame, ECB-PLUS™ Magnetic Brake, Electronic component, or defective Part and is the sole remedy of the warranty. The warranty does not cover normal wear and tear, improper assembly or maintenance, or installation of parts or accessories not originally intended or compatible with the Fitness Product as sold. The warranty does not apply to damage or failure due to accident, abuse, corrosion, discoloration of paint or plastic, or neglect. VISION FITNESS shall not be responsible for incidental or consequential damages. Parts and Electronic components reconditioned to As New Condition by VISION FITNESS or its vendors may sometimes be supplied as warranty replacement parts and constitute fulfillment of warranty terms. Any warranty replacement parts shall be warranted for the remainder of the original warranty term.

VISION FITNESS expressly disclaims all other warranties, express or implied, including but not limited to all warranties of fitness for a particular purpose or of merchantability. This warranty gives you specific legal rights and your rights may vary from state to state.

### WARRANTY REGISTRATION

Your warranty card must be completed and sent to VISION FITNESS before a warranty claim can be processed. You may also register via our website at [www.visionfitness.com](http://www.visionfitness.com). Inside the enclosed warranty card you will find a customer survey. Your care in completing the survey will be of value to us in serving you in the future. Comments and suggestions are always welcome. We are certain you will enjoy your new Bike. Thank you for selecting a VISION FITNESS product.

## DEVELOPING A FITNESS PROGRAM

### WARM UP

When you exercise you need more oxygen to fuel your muscles. This oxygen is carried to the muscles through blood. The increasing demands of exercise will cause increased breathing rate, heart rate, blood flow and blood temperature. As your blood temperature rises and more oxygen is released, the temperature of your muscles will increase. This allows the muscles to burn calories and create energy for exercise.

A warm-up activity should be a progressive aerobic activity that utilizes the muscles you will be using during your workout. There is no set intensity to warm-up with. A typical warm-up will produce a small amount of perspiration, but not leave you feeling fatigued. Intensity and fitness level will affect the duration of your warm-up, but 5 to 10 minutes is usually recommended.

A gradual warm-up will do the following:

- Produce faster more forceful muscle contractions
- Increase your metabolic rate so oxygen is delivered to the working muscles more quickly
- Leads to efficient calorie burning by increasing your core body temperature
- Prevent injuries by improving the elasticity of your muscles
- Allow you to work out comfortably longer because your energy systems are able to exercise, preventing the buildup of lactic acid in the blood.
- Improves joint range of motion
- Psychologically prepares you for higher intensities by increasing your arousal and focus on exercise

## FLEXIBILITY

Before stretching, take a few minutes to warm-up as stretching a cold muscle can cause injury. When stretching you should start slowly, exhaling as you gently stretch the muscle. Try to hold each stretch for at least 15 to 30 seconds. Don't bounce when you stretch. Holding a stretch is more effective and less of a risk for injury. Don't strain or push a muscle too far. If a stretch hurts, ease up.

### SEATED TOE TOUCH

Sit on the floor with your legs together and straight out in front of you. Do not lock your knees. Extend your fingers toward your toes exhaling as you go. Hold the stretch for 15 to 30 seconds. Return to the start position and repeat the stretch as necessary.

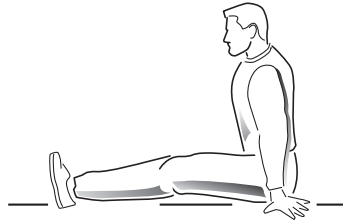

### STANDING QUADRICEPS STRETCH

Using a wall or your Bike to provide balance, grasp your left ankle with your left hand and hold to stretch. Your knee should be pointing to the floor. Hold the stretch for 15 to 30 seconds. Repeat with your right leg and continue to alternate for amount of desired repetitions.

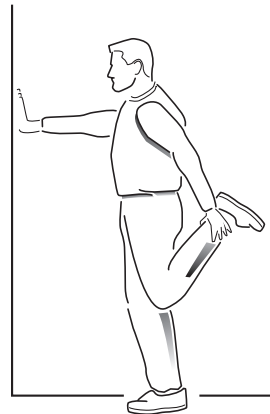

## STANDING CALF STRETCH

Standing about 3 feet from a wall, take one step forward with your left foot. Place your hands on the wall in front of you. Your elbows slightly bent, shoulders, hips, and feet are pointed directly towards the wall. Bend your left leg slowly using the movement to control the amount of stretch in the right calf. Your heels should stay on the ground. Slowly bring yourself back to the starting position and switch legs. Alternate for the amount of desired repetitions.





## EXERCISE GUIDELINES

The American Council of Sports Medicine (A.C.S.M.) recommends the following exercise guidelines, for healthy aerobic activity:

**Frequency:** Exercise 3 to 5 days each week.

**Warm-up:** Warm-up 5 to 10 minutes before aerobic activity.

**Duration:** Maintain your exercise intensity for 20 to 60 minutes.

**Cool Down:** Gradually decrease the intensity of your workout, then stretch to cool down during the last 5 to 10 minutes.

**NOTE:** If weight loss is major goal, participate in your aerobic activity at least 30 minutes for five or more days each week.

## EXERCISE INTENSITY

To reap the most cardiovascular benefits from your workout, it is necessary to exercise within a recommended intensity. The three ways to monitor exercise intensity are Target Heart Rate, Perceived Exertion, and the Talk Test.

## TARGET HEART RATE

Target Heart Rate is a percentage of your maximum heart rate. Target Rate will vary for each individual, depending on age, current level of conditioning, and personal fitness goals. Exercise heart rate should range from 50 - 90% of the predicted maximum heart rate for most healthy adults. A guideline for Target Heart Rate follows:

- 50 - 60% Beginning Exercisers or Health Concerns
- 60 - 75% General Fitness or Weight Loss
- 75 - 90% Improve Aerobic Capacity or Athletic Performance

Use the chart below to determine your Target Heart Rate.

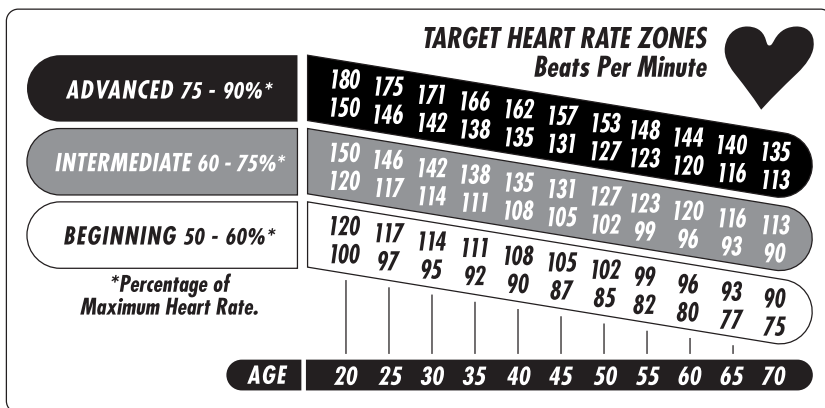

## RATE OF PERCEIVED EXERTION

Rate of Perceived Exertion (R.P.E.) is one of the easiest ways to monitor exercise intensity. By becoming familiar with the RPE scale, you can continually assess your level of intensity and insure a level of exertion that is comfortable. An increase in exercise intensity is directly related to elevation in exercise heart rate. Consequently RPE can be used alone or together with heart rate when monitoring exercise intensity.

### RPE SCALE

0	Nothing at all
.5	Very, very weak
1	Very weak
2	Weak
3	Moderate
4	Somewhat strong
5	Strong
6	
7	very strong
8	
9	
10	Very, very, strong
	Maximal

The recommended RPE range for most people is between 3 (moderate) and 5 (strong). The RPE should be independent of your pace; it is dependent on the feelings caused by the exertion.

### TALK TEST

The "Talk Test" is a quick and simple check of exercise intensity. If you have trouble completing a sentence, you are working too hard. You should be able to speak freely without gasping for air.

## ACHIEVING YOUR FITNESS GOALS

An important step in developing a long term fitness program is to determine your goals. Is your primary goal for exercising on your VISION FITNESS Product to lose weight? Improve muscle tone? Relieve stress? Prepare for the spring racing schedule? Knowing what your goals are will help you develop a more successful exercise program. Below are some common exercise goals:

- Weight Loss & Maintenance
- Improve Body Shape & Tone
- Increase Energy Level
- Improve Cycling/Cross Sports Performance
- Improve Cardiovascular Endurance
- Stress Reduction
- Improve Sleep Patterns
- Improve muscular strength

If possible try to define your personal goals in precise, measurable terms, and then put your goals in writing. The more specific you can be, the easier it will be to track your progress. If your goals are long term, divide them up into monthly and weekly segments. Longer term goals can lose some of the immediate motivation benefits. Short term goals are easier to achieve. Your VISION FITNESS Product console provides you with several readouts that can be used to record your progress. You can track Distance, Calories or Time. Time is the most important and useful of test functions.

## SAMPLE GOALS:

Goal-setting is a popular motivational technique. It's important to set goals and reward yourself when initiating a new exercise program because you're attempting to break current patterns and form a new habit. Whether you use this technique or another, make fitness a priority in your life. You can achieve the ultimate reward to yourself: you can establish the exercise habit!

Some sample goals may be:

- To strengthen my heart by exercising 24 minutes three days a week.  
(Goal Measurement: Exercise Time=72 minutes a week).
- To improve my body's ability to burn fat by exercising at a low intensity for 48 minutes per day, 5 days a week.  
(Goal Measurement: Exercise Time=240 minutes per week).
- To burn off work related stress by exercising for 20 minutes a day on work days.  
(Goal Measurement: Exercise Time=100 minutes per week).

## KEEPING AN EXERCISE DAIRY

Photocopy the weekly and annual log sheets on the following pages to make your personal exercise log book. As time goes by you'll be able to look back with pride at the work you've done. As your fitness improves, you can look back and see how far you've come.

Week #

Weekly Goals: \_\_\_\_\_

Scheduled Workout Time: \_\_\_\_\_

Reward: \_\_\_\_\_

Day	Date	Workload Level	Exercise Time	Distance	Comments
Sunday					
Monday					
Tuesday					
Wednesday					
Thursday					
Friday					
Saturday					
Totals			<input type="text"/>	<input type="text"/>	

Week #

Weekly Goals: \_\_\_\_\_

Scheduled Workout Time: \_\_\_\_\_

Reward: \_\_\_\_\_

Day	Date	Workload Level	Exercise Time	Distance	Comments
Sunday					
Monday					
Tuesday					
Wednesday					
Thursday					
Friday					
Saturday					
Totals			<input type="text"/>	<input type="text"/>	

Week #

Weekly Goals: \_\_\_\_\_

Scheduled Workout Time: \_\_\_\_\_

Reward: \_\_\_\_\_

Day	Date	Workload Level	Exercise Time	Distance	Comments
Sunday					
Monday					
Tuesday					
Wednesday					
Thursday					
Friday					
Saturday					
Totals			<input type="text"/>	<input type="text"/>	

Week #

Weekly Goals: \_\_\_\_\_

Scheduled Workout Time: \_\_\_\_\_

Reward: \_\_\_\_\_

Day	Date	Workload Level	Exercise Time	Distance	Comments
Sunday					
Monday					
Tuesday					
Wednesday					
Thursday					
Friday					
Saturday					
Totals			<input type="text"/>	<input type="text"/>	

<b>January</b>		
<i>Week</i>	<i>Minutes</i>	<i>Distance</i>
1		
2		
3		
4		
5		
<b>Totals</b>	<input type="text"/>	<input type="text"/>
<b>Reward</b>	_____	

<b>February</b>		
<i>Week</i>	<i>Minutes</i>	<i>Distance</i>
1		
2		
3		
4		
5		
<b>Totals</b>	<input type="text"/>	<input type="text"/>
<b>Reward</b>	_____	

<b>March</b>		
<i>Week</i>	<i>Minutes</i>	<i>Distance</i>
1		
2		
3		
4		
5		
<b>Totals</b>	<input type="text"/>	<input type="text"/>
<b>Reward</b>	_____	

<b>April</b>		
<i>Week</i>	<i>Minutes</i>	<i>Distance</i>
1		
2		
3		
4		
5		
<b>Totals</b>	<input type="text"/>	<input type="text"/>
<b>Reward</b>	_____	

<b>May</b>		
<i>Week</i>	<i>Minutes</i>	<i>Distance</i>
1		
2		
3		
4		
5		
<b>Totals</b>	<input type="text"/>	<input type="text"/>
<b>Reward</b>	_____	

<b>June</b>		
<i>Week</i>	<i>Minutes</i>	<i>Distance</i>
1		
2		
3		
4		
5		
<b>Totals</b>	<input type="text"/>	<input type="text"/>
<b>Reward</b>	_____	



## July

Week	Minutes	Distance
------	---------	----------

1		
---	--	--

2		
---	--	--

3		
---	--	--

4		
---	--	--

5		
---	--	--

<b>Totals</b>	<input type="text"/>	<input type="text"/>
---------------	----------------------	----------------------

<b>Reward</b>	_____	
---------------	-------	--

## August

Week	Minutes	Distance
------	---------	----------

1		
---	--	--

2		
---	--	--

3		
---	--	--

4		
---	--	--

5		
---	--	--

<b>Totals</b>	<input type="text"/>	<input type="text"/>
---------------	----------------------	----------------------

<b>Reward</b>	_____	
---------------	-------	--

## September

Week	Minutes	Distance
------	---------	----------

1		
---	--	--

2		
---	--	--

3		
---	--	--

4		
---	--	--

5		
---	--	--

<b>Totals</b>	<input type="text"/>	<input type="text"/>
---------------	----------------------	----------------------

<b>Reward</b>	_____	
---------------	-------	--

## October

Week	Minutes	Distance
------	---------	----------

1		
---	--	--

2		
---	--	--

3		
---	--	--

4		
---	--	--

5		
---	--	--

<b>Totals</b>	<input type="text"/>	<input type="text"/>
---------------	----------------------	----------------------

<b>Reward</b>	_____	
---------------	-------	--

## November

Week	Minutes	Distance
------	---------	----------

1		
---	--	--

2		
---	--	--

3		
---	--	--

4		
---	--	--

5		
---	--	--

<b>Totals</b>	<input type="text"/>	<input type="text"/>
---------------	----------------------	----------------------

<b>Reward</b>	_____	
---------------	-------	--

## December

Week	Minutes	Distance
------	---------	----------

1		
---	--	--

2		
---	--	--

3		
---	--	--

4		
---	--	--

5		
---	--	--

<b>Totals</b>	<input type="text"/>	<input type="text"/>
---------------	----------------------	----------------------

<b>Reward</b>	_____	
---------------	-------	--





*vision  
fitness*

*the vision to succeed*

---



621-D East Lake Street • P.O. Box 280 • Lake Mills, WI 53551  
toll free 1.800.335.4348 • phone 1.920.648.4090 • fax 1.920.648.3373  
[www.visionfitness.com](http://www.visionfitness.com)

©2001 Vision Fitness. All Rights Reserved. HRT is a Trademark of Vision Fitness. 4.01  
Part #Z32CB11-OM1807PRD  
OM18.07PRD  
REV1