

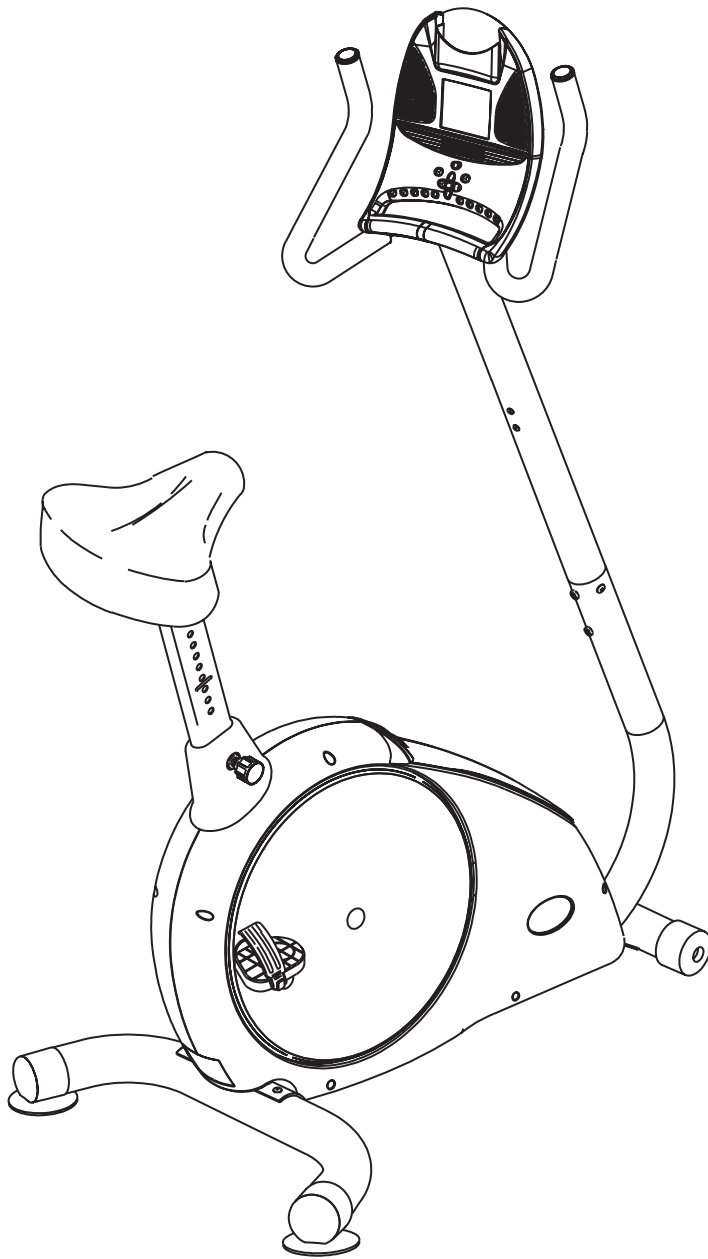

Designed for life.™

HZ SERIES
B51
B52HR



Upright User's Guide

Table of Contents

IMPORTANT PRECAUTIONS	3
BEFORE YOU BEGIN	6
ASSEMBLY (B51 & B52HR)	7
UPRIGHT OPERATION & ADJUSTMENT	10
CONSOLE FEATURES & DISPLAY (B51 & B52HR)	12
PROGRAM PROFILES	19
PROGRAM CHARTS	20
USING YOUR RACE PROGRAM	22
USING YOUR THR ZONE PROGRAMS 1 & 2	23
USING YOUR CUSTOM USER PROGRAMS 1 & 2	24
TROUBLESHOOTING & MAINTENANCE PROCEDURES	25
COMMON PRODUCT QUESTIONS	28
CONDITIONING GUIDELINES	39
MONITORING YOUR HEART RATE	31
HEART RATE CHART	32
DEVELOPING A FITNESS PROGRAM & WARM UP/COOL DOWN	33
ACHIEVING YOUR FITNESS GOALS	34
WEEKLY LOG SHEETS	35
MONTHLY LOG SHEETS	36
LIMITED WARRANTY	37



CAUTION

Read all precautions and instructions in this manual before using this equipment.
Save this manual for future reference.

Important Precautions

SAVE THESE INSTRUCTIONS

When using an electrical product, basic precautions should always be followed. Read all instructions before using this exercise product.



WARNING!

To reduce the risk of burns, fire, electrical shock or injury to persons:

- Use this exercise product for its intended use as described in this user's guide.
- Do not use attachments not recommended by the manufacture.
- Never drop or insert any object into any opening.
- Do not remove the upright bike's side covers. Service should be performed only by an authorized Horizon Fitness service provider.
- Never operate this upright bike if it has a damaged cord or plug, if it is not working properly, if it has been damaged, or immersed in water.
- Keep the cord away from heated surfaces.
- Do not use outdoors.
- Only use the power cord provided with your Horizon Fitness upright bike.
- Never place the power cord under carpeting or place any object on top of the power cord, which may pinch or damage it.
- Unplug your Horizon Fitness upright bike before moving it.



CAUTION!

- If you experience chest pains, nausea, dizziness or shortness of breath, stop exercising immediately and consult your physician before continuing.
- Do not turn pedals by hand.
- Do not wear clothing that might catch on any part of the upright bike.
- Make sure handlebars are secure before each use.
- Read the owner's guide before operating this upright bike.
- Maintain a comfortable pace. Do not 'sprint' above 125 rpms on this machine.
- To maintain balance it is recommended to keep a grip on the handlebars while exercising, mounting or dismounting the machine.

OPERATION

It is essential that your upright bike is used only indoors, in a climate controlled room. If your upright bike has been exposed to colder temperatures or high moisture climates, it is strongly recommended that the upright bike is warmed up to room temperature before first time use. Failure to do so may cause premature electronic failure.

CHILDREN

- Keep children off of your upright bike at all times.
- When the upright bike is in use, young children and pets should be kept at least 10 feet away.

CLEANING

- Clean with soap and slightly damp cloth only. Never use solvents.

USER CAPACITY

- B51=250 lbs
- B52HR=275 lbs

CAUTION:

BEFORE BEGINNING ANY EXERCISE PROGRAM, ALWAYS CONSULT YOUR PHYSICIAN. IF YOU EXPERIENCE CHEST PAINS, NAUSEA, DIZZINESS OR SHORTNESS OF BREATH, STOP EXERCISING AND CONSULT YOUR PHYSICIAN BEFORE CONTINUING.

IMPORTANT: PLEASE READ BEFORE USE!

ASSEMBLY



CAUTION!

There are several areas during the assembly process of a Horizon Fitness upright bike that special attention must be paid. It is very important to follow the assembly instructions correctly and to make sure all parts are firmly tightened. If the assembly instructions are not followed correctly, the upright bike could have frame parts that are not tightened and will seem loose and may cause irritating noises. To prevent damage to the upright bike, the assembly instructions must be reviewed and corrective actions should be taken.

Before proceeding, find your upright bike's serial number and model name located on the front foot tube and enter it in the space provided below:

SERIAL NUMBER AND MODEL NAME LOCATION:

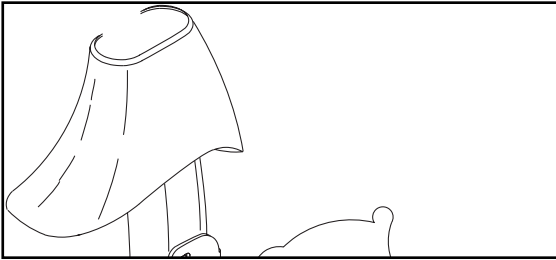

ENTER YOUR SERIAL NUMBER IN BOX BELOW:

Refer to this number when calling for service, and also enter this serial number on your Warranty Card and in your own records. Be sure to read the Safety Instructions and complete Owner's Guide before using your new Horizon Fitness upright bike.

WARRANTY REGISTRATION

Your warranty card must be completed and sent to Horizon Fitness within thirty days of purchase or registered on line at www.horizonfitness.com, before a warranty claim can be processed. Please keep receipt with owner's guide as it may be required for a warranty claim. Make sure to send in warranty registration card to value your warranty.

Before You Begin

CONGRATULATIONS!

 on choosing an Horizon Fitness upright bike.

You've taken an important step in developing and sustaining an exercise program! Your Horizon Fitness upright bike is a tremendously effective tool for achieving your personal fitness goals. Regular use of your Horizon Fitness upright bike can improve the quality of your life in so many ways.

Here are just a few of the health benefits of aerobic exercise:

- Weight Loss
- A Healthier Heart
- Improved Muscle Tone
- Increased Daily Energy Levels
- Reduced Stress
- Help In Countering Anxiety and Depression
- An Improved Self Image

The key to reaping these benefits is to develop the exercise habit. Your new Horizon Fitness upright bike will help you eliminate the obstacles that prevent you from getting in your exercise time. Inclement weather and darkness won't interfere with your workout when you use your Horizon Fitness upright bike in the comfort of your home. This manual provides you with basic information for using and enjoying your new machine. A more complete knowledge of your new Horizon Fitness upright bike will assist you in realizing your goal of a healthy lifestyle.

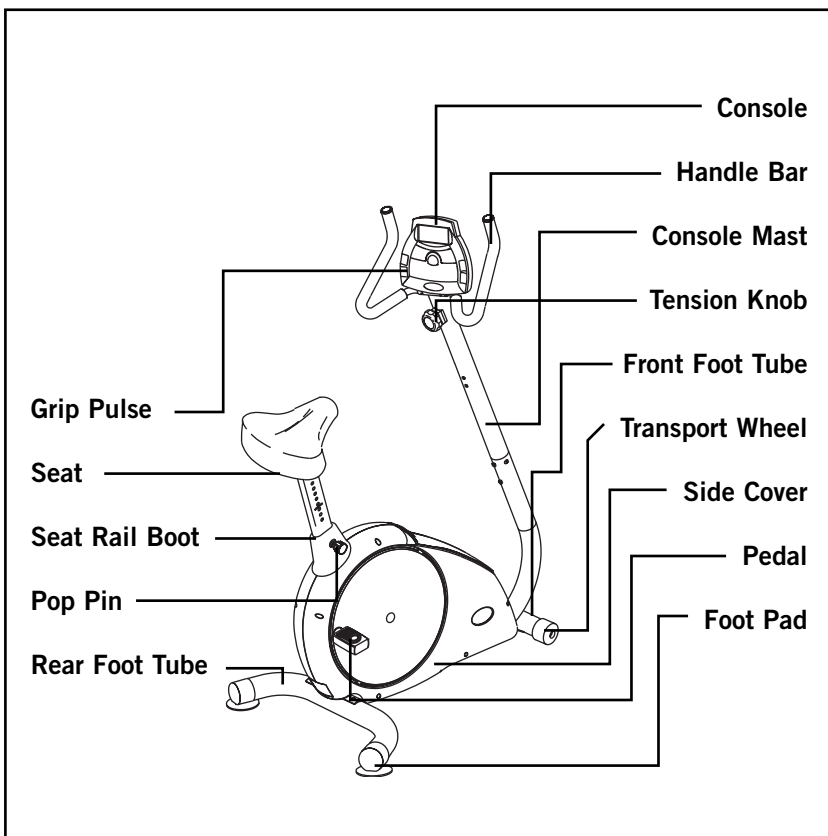

Note: Tension Knob not included with the B52HR model.

Assembly

UNPACKING

Unpack the product where you will be using it. Place the product on a level flat surface. It is recommended that you place a protective covering on your floor. **Note:** It is recommended that you apply grease to the threads of each bolt as you assemble the product, to prevent loosening and noise. Also, during each assembly step, ensure that ALL nuts and bolts are in place and partially threaded in before completely tightening any ONE bolt.

PARTS

- 1 Rear Foot Tube
- 1 Handlebar Set
- 1 Seat Post
- 1 Seat
- 1 Console Mast
- 1 Console
- 1 Power supply (B52HR model only)
- 1 Tension Knob (B51 model only)
- 2 Pedals
- 2 Mobile Wheels
- 2 Mobile Wheel Sleeves
- 2 AA Batteries (B51 model only)
- 1 Hardware Pack

TOOLS (included)

- 5mm Allen Wrench/Phillips Screw Driver
- Flat Wrench

If you have any questions, or if there are any missing parts, we will guarantee complete satisfaction.
PLEASE CALL OUR TOLL-FREE DIRECT CUSTOMER ASSISTANCE CENTER @ 1-800-244-4192
Mon.-Fri., 8 a.m.-5 p.m. CST (excluding holidays).

B51/B52HR HARDWARE

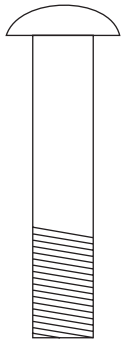

A) 45mm Bolt
Quantity: 2

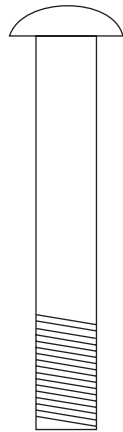

B) 90mm Bolt
Quantity: 2

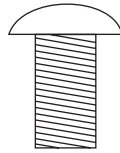

C) 15mm Bolt
Quantity: 4

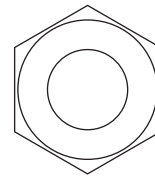

D) Acorn Nut
Quantity: 2

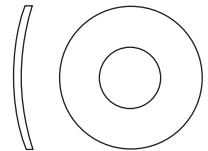

E) 20mm Arc Washer
Quantity: 10



F) 12mm Screw
Quantity: 2

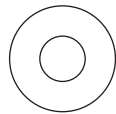

G) 14mm Washer
Quantity: 2

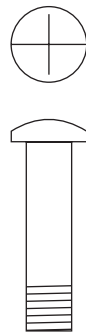

H) 20mm Bolt
Quantity: 2

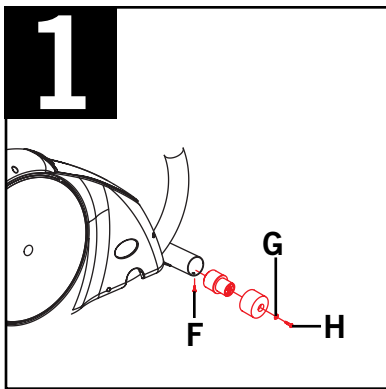

**STEP 1:
ATTACH MOBILE WHEEL/SLEEVE.**

Note: Make sure not to tighten bolts until all assembly steps have been completely assembled and aligned.

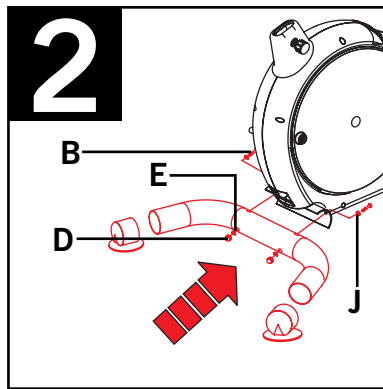

**STEP 2:
ATTACH REAR FOOT SUPPORT TUBE.**

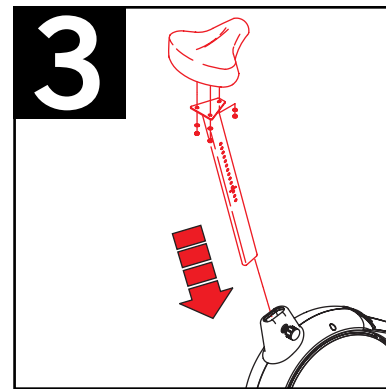

**STEP 3:
ATTACH SEAT AND SEAT POST.**

Note: Slide seat post into position and lock with the pop pin.
Note: Bolts, nuts and washers are pre-attached to seat.

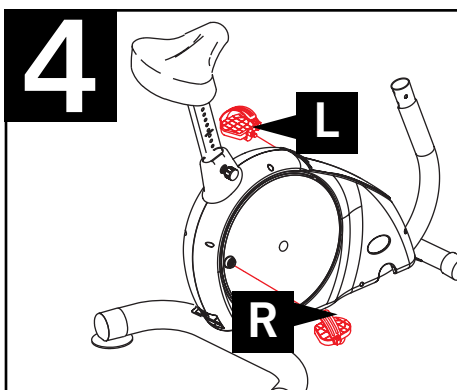

**STEP 4:
ATTACH LEFT & RIGHT PEDALS.**

Note: Both pedals are labeled L for left and R for right. To tighten turn the left pedal COUNTER CLOCKWISE and the right pedal COUNTER CLOCKWISE.

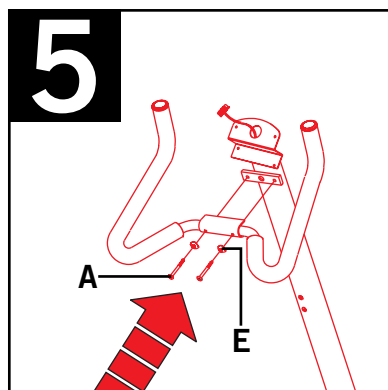

**STEP 5:
ATTACH HANDLEBAR.**

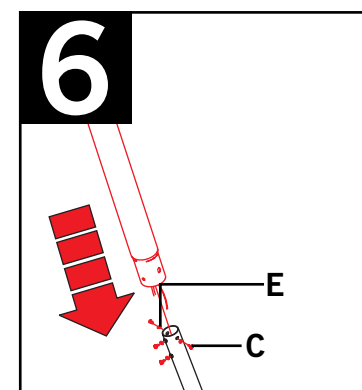

**STEP 6:
ATTACH CONSOLE MAST.**

Note: Make sure to loosen the water bottle screws in order to fit the console cable through the mast. DO NOT PINCH WIRES!

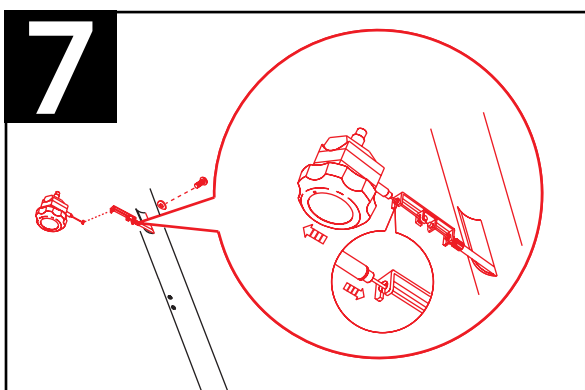

**STEP 7:
ATTACH TENSION KNOB. (B51 model only)**

Note: Bolt is pre-attached to tension knob.
The resistance indicator is located on the front of the tension knob.

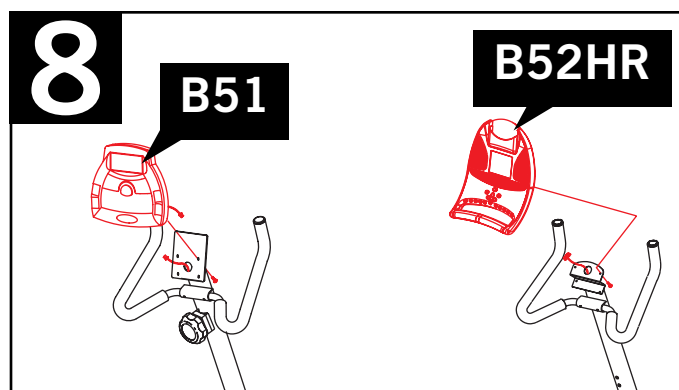

**STEP 8:
ATTACH CONSOLE AND CONNECT ALL WIRES.**

Note: DO NOT PINCH WIRES!
Bolts are pre-attached.

Upright Operation & Adjustment

POWER

Your programmable (B52HR model only) upright bike is powered by a power supply. The power supply must be plugged into the power jack, which is located in the rear of the machine near the rear foot tube.

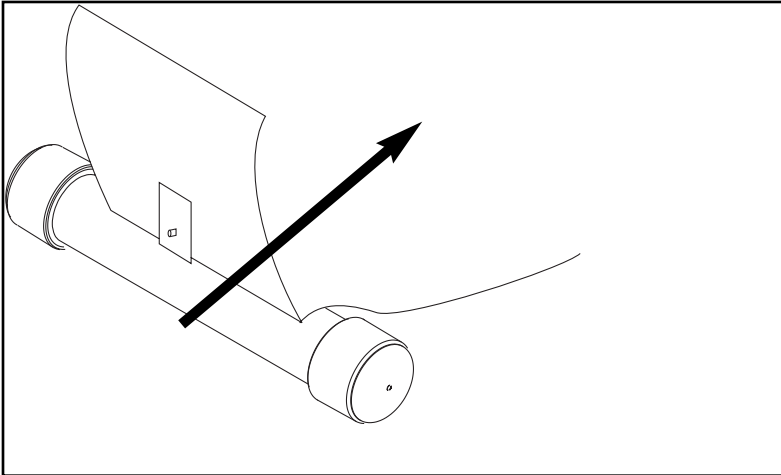

POWER

Your manual (B51 model only) upright is powered by 2 AA batteries, which are replaceable through the back side of the console.

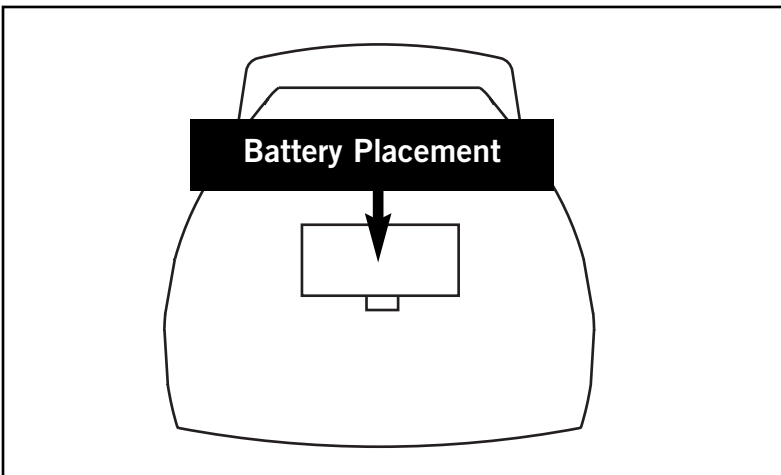

MOVING

Your Horizon Fitness upright bike has a pair of transport wheels built into the front of the frame. To move, firmly grasp the vertical seat post and one of the handlebars. Carefully lift and roll.

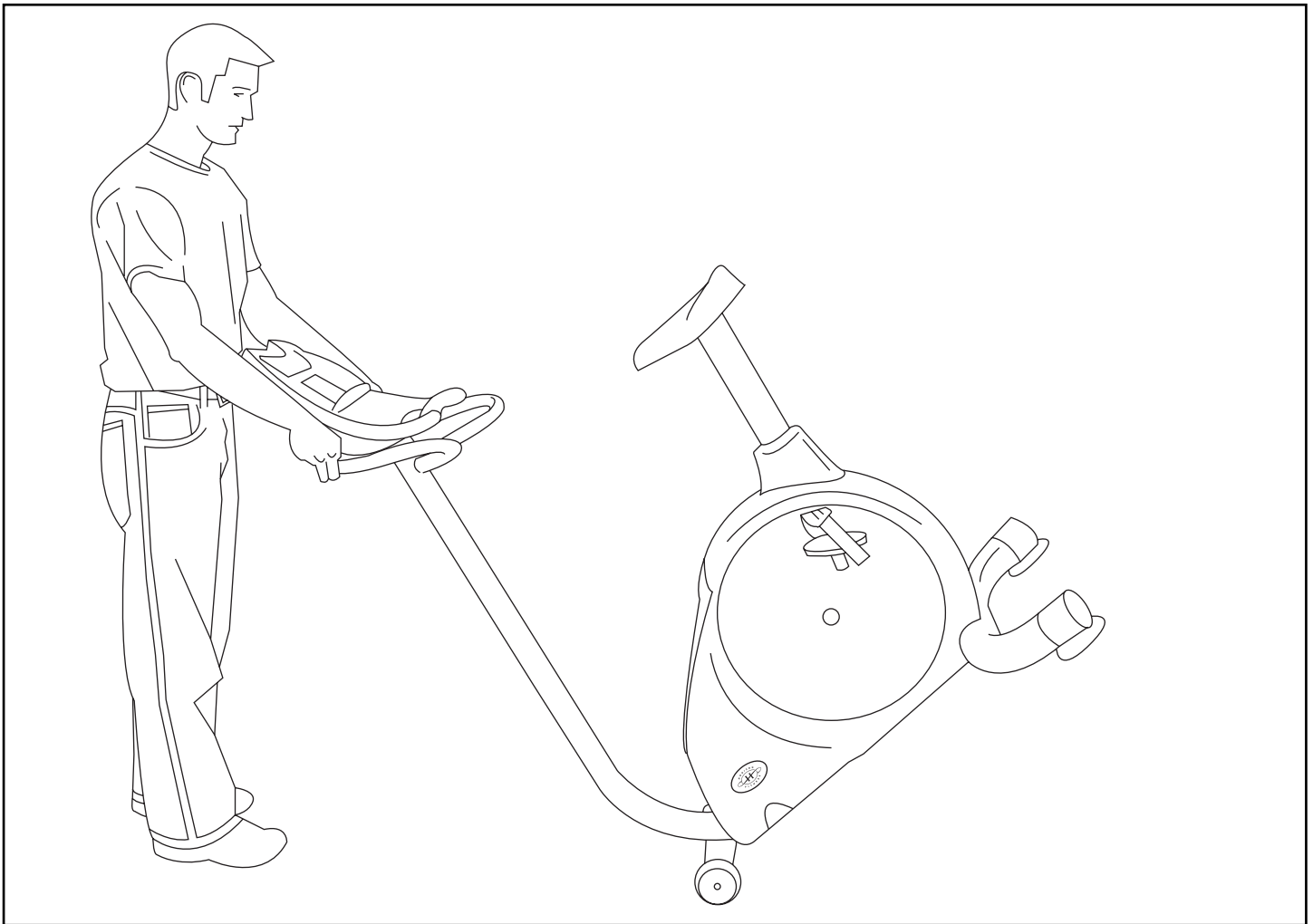

Note: Your console may vary from the above B52HR diagram.



CAUTION!

Our upright bikes are well built and heavy, weighing up to 150lbs.! Use care and additional help if necessary when moving.

Console Features & Display

B51 QUICK START UP

Simply begin exercising. The console will automatically begin counting up and tracking your information.

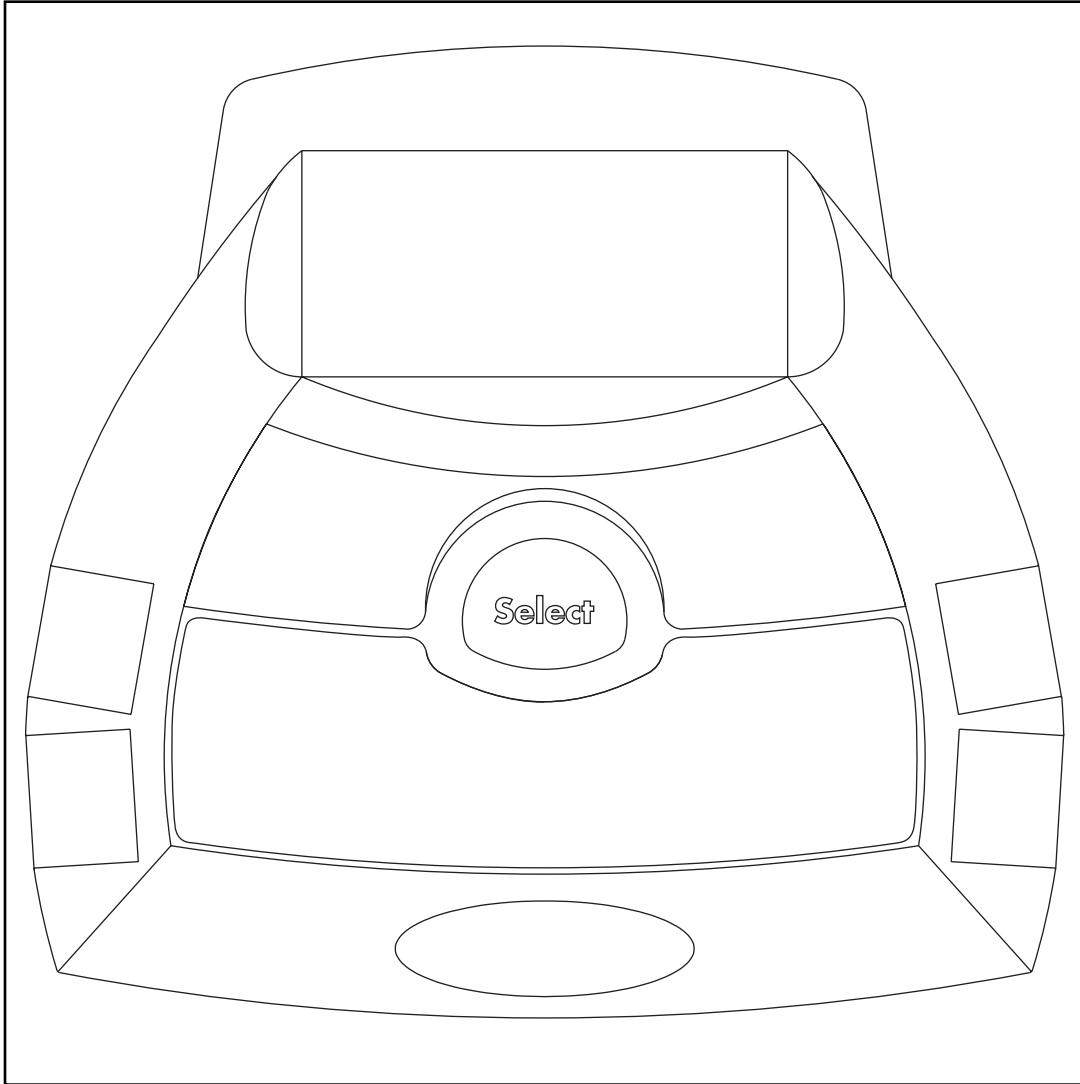

RESET

Press and hold the 'SELECT' button on the console.

SELECTING OPTIONAL FEEDBACK

Press the 'SELECT' button on the console to scroll through and view your speed, time, distance, odometer, and calories.

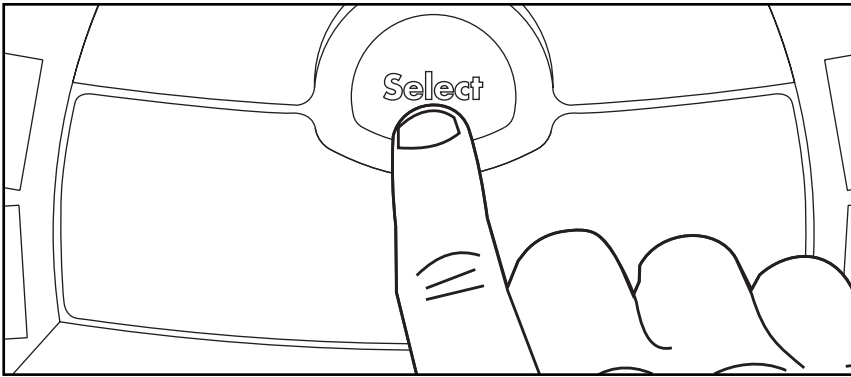

STARTING YOUR WORKOUT

Start pedaling, the console will automatically begin counting down.

CHOOSING A RESISTANCE

At any time during your workout you can change your resistance by adjusting the tension knob located on the console mast. The resistance levels vary from 1-15; 1 being the easiest, 15 being the most difficult. Turn the tension knob clockwise to increase resistance.

FINISHING YOUR WORKOUT

Remember to gradually slow down your pace before stopping your workout. After you have finished your workout, the console will 'beep' several times to let you know your workout is finished.

TIME

Shown as Minutes:Seconds. View the time remaining or the time elapsed in your workout.

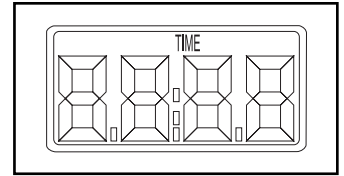

DISTANCE

Shown as Miles. View the accumulated distance during your workout.

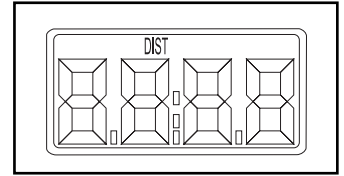

SPEED

Shown as your speed in miles per hour.

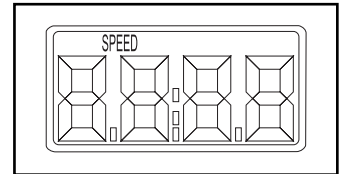

ODOMETER

Shows your accumulated distance for all your previous workouts. It will continue to track this distance until the batteries die or are pulled out.

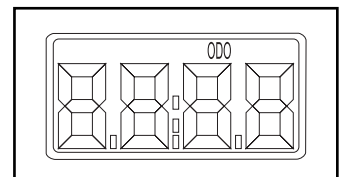

CALORIES

Shown as total accumulated calories burned during your workout.

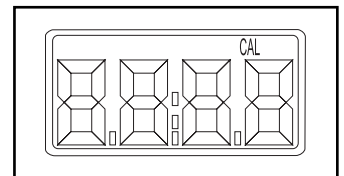

PULSE

Shown as Beats Per Minute. Used to monitor your heart rate during your workout (displayed when contact is made with both grips. Pulse can only be viewed while on the pulse screen).

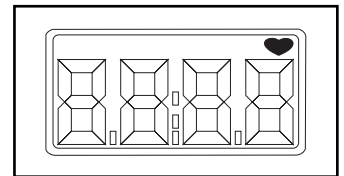

B52HR QUICK START UP

Simply press the 'Start' button to begin exercising. The program will automatically default to the Manual program unless another program is selected.

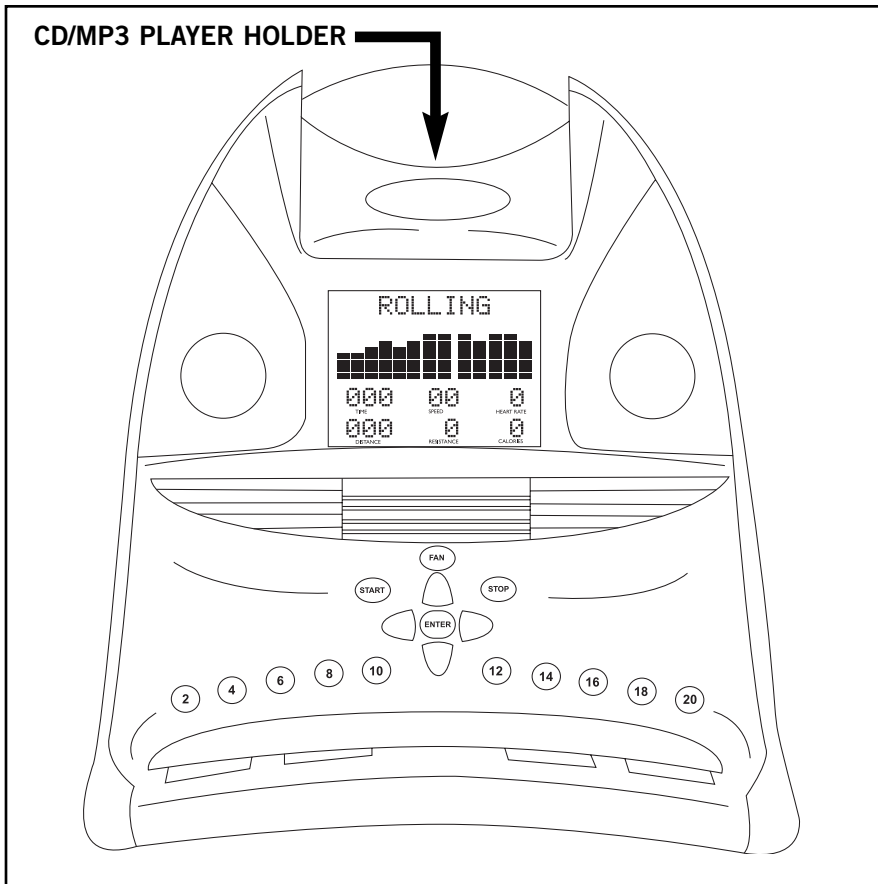

RESET

Press and hold the 'STOP' button to reset the console.

LOCATING THE SPEAKER INPUT JACK

Compatible with AM/FM/CD/MP3 players and cassette, etc.

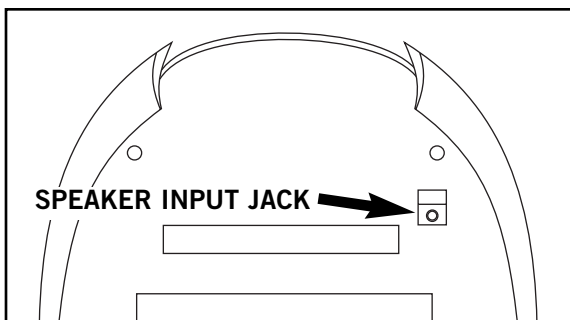

TIME

Shown as Minutes:Seconds. View the time remaining or the time elapsed in your workout.

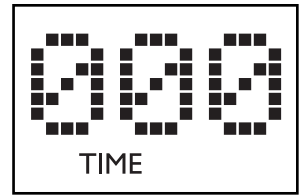

DISTANCE

Shown as Miles. View the accumulated distance during your workout.

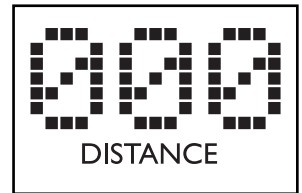

CALORIES

Shown as total accumulated calories burned during your workout.



RPM

Shown as Revolutions per Minute. Improve striding technique while reducing leg muscle fatigue by striding between 60 & 70 RPM.



RESISTANCE

During a workout, the amount of resistance can be adjusted by pressing the plus 'Up' or 'Down' buttons or the quick resistance keys on the console. The resistance levels vary from level 1 to 20 quick speed keys (level 1 being the easiest and level 20 being the most difficult).



WATTS

A measurement of your energy expenditure. May be used to evaluate and quantify your fitness progress over time.

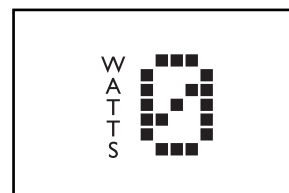

HEART RATE

Shown as Beats per Minute. You can monitor your heart rate at any time during your workout by holding the heart rate grips or wearing the chest transmitter (B52HR model only, chest strap sold separately)

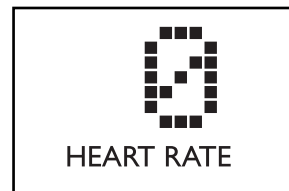

PROFILE

Allows you to view your program intensity while you exercise. Each horizontal row of bars represents 2 resistance levels.

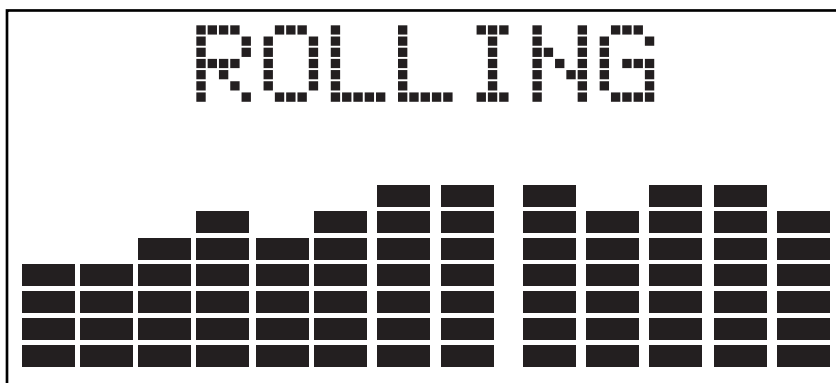

CHOOSING A PROGRAM

With the program text scrolling, press the arrow keys to scroll through the different programs. Press 'ENTER' to choose your desired program. Once you choose your program, you will see the resistance level scrolling across the screen.

CHOOSING A LEVEL

With the level text scrolling, press the arrow keys to scroll through the different levels. Press 'ENTER' to choose your desired level. Once you choose your level, you will see the time scrolling across the screen.

CHOOSING A RESISTANCE (Manual Program)

With the resistance text scrolling, press the arrow keys or quick resistance keys to scroll through the different resistance levels. Press enter to choose your desired resistance. Once you choose your resistance, you will see the time scrolling across the screen.

CHOOSING A TIME

With the time text scrolling, press the arrow keys to scroll through the different times. Press enter to choose your desired time. Once you choose your time, press the 'Enter' button and begin your workout.

CHOOSING YOUR WEIGHT

With the weight text scrolling, press the arrow keys to scroll through the different weights. Press enter to choose your desired weight. Once you choose your weight, press the 'Start' button and begin your workout.

FINISHING YOUR WORKOUT

Press the 'Stop' button to pause your workout, press and hold to reset your workout. Remember to gradually slow down your pace before stopping or pausing your workout. After you have finished your workout, the console will retain the data from your workout for 30 seconds before resetting.

Program Profiles

P1 MANUAL

Customized workouts, allowing the user to adjust resistance level to the user's preference.

P2 INTERVALS

Improves your strength, speed, and endurance by raising and lowering the resistance levels throughout your workout to involve both your heart and muscles.

P3 ROLLING

Maintains weight by gradually raising and lowering the resistance level to gradually raise and lower your heart rate.

P4 WEIGHT LOSS

Promotes weight loss by raising and lowering the resistance level, while keeping you in your fat burning zone.

P5 TOUR

Simulates a gradual hill climb to strengthen your leg muscles and improve your cardiovascular health.

P6 RACE

A great motivational program for competitive individuals that allows the user to compete with a computer pacer to the finish line.

P7 THR ZONE 1

Benefits weight loss by maintaining an optimum exercise level to burn fat, while adjusting the resistance to keep you in your target heart rate zone.

P8 THR ZONE 2

Benefits weight loss by maintaining an optimum exercise level to burn fat, while adjusting the resistance to keep you in your target heart rate zone.

P9 CUSTOM USER PROGRAM 1

Customized workout, time defaults to 30 minutes.

P10 CUSTOM USER PROGRAM 2

Customized workout, time defaults to 30 minutes.

Program Charts

P2 INTERVALS

Time-based goal with 10 difficulty levels to choose from.

Peak segments last 30 seconds, valley segments last 90 seconds.

Warm-up and cool-down last 5:00 minutes each and are included in program times.

Resistance	Warm Up		Program segments															Cool Down	
			1	2	3	4	5	6	7	8	9	10	11	12	13	14	15		
Level 1	1	1	2	5	2	5	2	5	2	5	2	5	2	5	2	5	2	1	1
Level 2	1	1	2	6	2	6	2	6	2	6	2	6	2	6	2	6	2	1	1
Level 3	1	2	3	7	3	7	3	7	3	7	3	7	3	7	3	7	3	2	1
Level 4	2	2	3	8	3	8	3	8	3	8	3	8	3	8	3	8	3	2	2
Level 5	2	2	4	9	4	9	4	9	4	9	4	9	4	9	4	9	4	2	2
Level 6	2	3	4	10	4	10	4	10	4	10	4	10	4	10	4	10	4	3	2
Level 7	2	3	5	11	5	11	5	11	5	11	5	11	5	11	5	11	5	3	2
Level 8	3	3	5	12	5	12	5	12	5	12	5	12	5	12	5	12	5	3	3
Level 9	3	3	6	13	6	13	6	13	6	13	6	13	6	13	6	13	6	3	3
Level 10	3	4	6	14	6	14	6	14	6	14	6	14	6	14	6	14	6	4	3

P3 ROLLING

Time-based goal with 10 difficulty levels to choose from.

All segments last 10 seconds.

Warm-up and cool-down last 5:00 minutes each and are included in program times.

Resistance	Warm Up		Program segments															Cool Down	
			1	2	3	4	5	6	7	8	9	10	11	12	13	14	15		
Level 1	1	1	1	2	3	4	5	6	5	4	3	2	1	2	3	4	5	4	3
Level 2	1	2	2	3	4	5	6	7	6	5	4	3	2	3	4	5	6	5	3
Level 3	2	2	3	4	5	6	7	8	7	6	5	4	3	4	5	6	7	6	4
Level 4	2	3	4	5	6	7	8	9	8	7	6	5	4	5	6	7	8	7	4
Level 5	3	4	5	6	7	8	9	10	9	8	7	6	5	6	7	8	9	7	5
Level 6	3	5	6	7	8	9	10	11	10	9	8	7	6	7	8	9	10	8	5
Level 7	4	5	7	8	9	10	11	12	11	10	9	8	7	8	9	10	11	8	6
Level 8	4	6	8	9	10	11	12	13	12	11	10	9	8	9	10	11	12	9	6
Level 9	5	7	9	10	11	12	13	14	13	12	11	10	9	10	11	12	13	10	7
Level 10	5	8	10	11	12	13	14	15	14	13	12	11	10	11	12	13	14	11	7

P4 WEIGHT LOSS

Time-based goal with 10 difficulty levels to choose from.

All segments last 10 seconds.

Warm-up and cool-down last 5:00 minutes each and are included in program times.

Resistance	Warm Up		Program segments															Cool Down	
			1	2	3	4	5	6	7	8	9	10	11	12	13	14	15		
Level 1	3	4	5	5	4	3	2	2	3	4	5	5	4	3	2	2	3	2	2
Level 2	3	5	6	6	5	4	3	3	4	5	6	6	5	4	3	3	4	3	2
Level 3	4	5	7	7	6	5	4	4	5	6	7	7	6	5	4	4	5	4	3
Level 4	4	6	8	8	7	6	5	5	6	7	8	8	7	6	5	5	6	5	3
Level 5	5	7	9	9	8	7	6	6	7	8	9	9	8	7	6	6	7	5	4
Level 6	5	8	10	10	9	8	7	7	8	9	10	10	9	8	7	7	8	6	4
Level 7	6	8	11	11	10	9	8	8	9	10	11	11	10	9	8	8	9	7	5
Level 8	6	9	12	12	11	10	9	9	10	11	12	12	11	10	9	9	10	8	5
Level 9	7	10	13	13	12	11	10	10	11	12	13	13	12	11	10	10	11	8	6
Level 10	7	11	14	14	13	12	11	11	12	13	14	14	13	12	11	11	12	9	6

P5 TOUR

Distance-based program with 10 different difficulty levels to choose from.

Resistance	Warm Up	Program segments															Cool Down		Total distance	
		1	2	3	4	5	6	7	8	9	10	11	12	13	14	15				
Level 1	Resistance	2	2	3	4	3	5	3	4	5	4	5	3	4	4	3	4	3	2	2
	distance	142	212	283	256	113	387	91	351	333	301	301	165	288	434	312	310	150	113	300
Level 2	Resistance	2	3	4	5	4	6	4	5	6	5	6	4	6	4	5	5	4	3	2
	distance	165	248	330	295	129	466	97	369	431	407	339	179	368	548	349	376	166	125	332
Level 3	Resistance	3	4	5	6	5	7	5	6	7	6	7	5	7	5	6	6	5	4	3
	distance	169	253	337	308	142	484	97	389	441	413	349	187	376	560	373	383	172	129	344
Level 4	Resistance	3	5	6	7	6	8	6	7	8	7	8	6	8	6	7	7	6	5	3
	distance	169	254	338	327	187	500	106	416	462	430	373	201	393	572	396	401	178	134	356
Level 5	Resistance	4	5	7	8	7	9	7	8	9	8	9	7	9	7	8	8	7	5	4
	distance	170	254	339	256	113	387	91	351	333	433	375	205	405	575	400	410	180	135	360
Level 6	Resistance	4	6	8	9	8	10	8	9	10	430	8	10	8	9	9	8	6	4	
	distance	170	255	340	295	129	466	97	369	431	435	380	208	410	578	405	415	190	143	380
Level 7	Resistance	5	7	9	10	9	11	9	10	11	431	1	9	11	9	10	10	9	7	5
	distance	171	256	341	308	142	484	97	389	441	435	380	210	415	580	410	425	200	150	400
Level 8	Resistance	5	8	10	11	10	12	10	11	12	432	2	10	12	10	11	11	10	8	5
	distance	171	257	342	327	187	500	106	416	462	440	385	215	425	585	415	430	205	154	410
Level 9	Resistance	6	8	11	12	11	13	11	12	13	433	3	11	13	11	12	12	11	8	6
	distance	172	257	343	327	187	500	106	416	462	450	390	220	460	590	420	435	210	158	420
Level 10	Resistance	6	9	12	13	12	14	12	13	14	434	4	12	14	12	13	13	12	9	6
	distance	376	502	374	327	187	500	106	416	462	475	400	225	482	600	425	450	220	180	440

Distance = Yards

USING YOUR RACE PROGRAM

Your Race Program is designed to add motivation to a workout by allowing you to compete against a selected pacer. To use your Race Program, follow these instructions:

1. Choose the Race program by pressing the Arrow keys. Press 'ENTER'.
2. Choose the desired Pace (average speed) using the Arrow buttons. The pace range is 10 to 28mph in increments of 0.5mph, with 10mph being the lowest and 28mph being the highest. Once the desired Pace is selected, press 'ENTER'.
3. Choose the desired Distance by pressing the Arrow buttons. Press 'ENTER'.
4. Enter your weight with the Arrow buttons.
5. Press 'Start' and begin your Race Program.

This is a distance-based program, the time it will take you to complete the race is determined by the speed and distance selected. Upon pressing START, the program will be broken up into 15 segments. The first segment will be dedicated to a WARM-UP, which will be half of the selected pace (Speed). The middle segments will consist of the Race, with the last segment dedicated to a COOL-DOWN, which will be half of the selected Pace (Speed). Note: The race distance does not include the time for WARM-UP and COOL-DOWN (as they are a set time of 2.5 minutes each).

The speed across the top of the display represents the pacer speed. The top row of bars shows the components Pacer position. The bottom row bars indicates your position. If you trail the Pacer, you should pedal at a faster speed to catch and pass the Pacer.

You can adjust your resistance at any time during the program by pressing the quick resistance or up/down buttons.

If you beat the pacer to the finish line, the console will flash and scroll YOU WIN and begin your cool-down. If the pacer wins, the console will flash and scroll PACER WINS, you will finish your race and begin your cool-down.

USING YOUR THR ZONE PROGRAMS 1 & 2 (B52HR model only, chest strap sold separately)

The THR zone program is designed to keep the user at an optimum exercise level, while adjusting the resistance levels to keep the user at a target heart rate. To choose the THR zone program, follow these instructions.

1. Choose the THR zone program by pressing the Arrow buttons. Press 'ENTER'.
2. Determine your target THR zone by using the heart rate chart (reference target heart rate THR zone chart in table of contents). Choose your target pulse zone by pressing the 'Up' or 'Down' buttons. Your target THR zone should be set at a number that you will be able to exercise throughout the majority of your workout.
3. The THR zone program will have a 5 minute warm-up period before it will start adjusting the resistance levels to get you to your target pulse zone.
4. After the 5 minute warm-up period, the resistance levels will increase gradually to get the user to the selected target THR zone. Once the user is at the target pulse zone; plus or minus 5 beats, the resistance level will remain at the current resistance level.
5. If the actual heart rate of the user is above the target THR zone, the resistance levels will gradually begin decreasing to keep the user in the target pulse zone. If the user is more than 25 beats above the target THR zone, the console will shut down for safety purposes.
6. The last 5 minutes of the program will be dedicated to a cool-down period. At this time, the program will gradually decrease the resistance level to give the user a smooth and easy cool down.

Note: The chest strap (sold separately) is required to use the Target THR zone Program.

CHEST STRAP TRANSMITTER PLACEMENT AND MOISTENING THE ELECTRODES

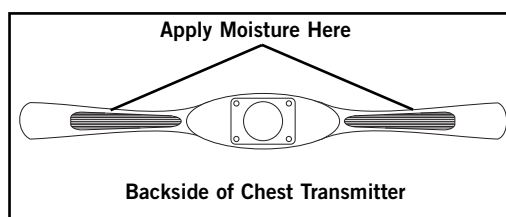
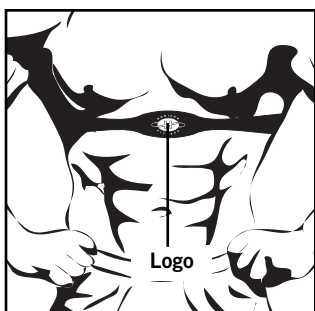

USING YOUR CUSTOM USER PROGRAMS 1 & 2

Your Custom user program 1 & 2 is designed to allow you to create your own programming, with the ability to save your program settings for future workouts. To use your Custom user program 1 & 2, follow these instructions:

- 1.** Once the Custom user program 1 & 2 has been selected, press 'ENTER'.
- 2.** Choose your desired time using the 'Arrow/Up/Down' buttons and press 'ENTER'.
- 3.** Choose your desired speed using the 'Arrow/Up/Down' buttons and press 'ENTER'. You will need to select a speed for all 15 segments, pressing 'ENTER' after each segment.
- 4.** Once you have chosen your desired resistance level for all 15 segments, press 'START' to begin your program. At this time, your program has been successfully saved into memory, and can be used for future workouts.
- 5.** To reset your program information and delete it from memory, press and hold the 'ENTER' button for 5 seconds once you have selected the Custom user program 1 & 2 in the start menu.
- 6.** While using your saved program in the Custom user program 1 & 2, you are able to adjust the resistance, but any changes will not be saved.

Troubleshooting & Maintenance Procedures

WHAT KIND OF ROUTINE MAINTENANCE IS REQUIRED?

We use sealed bearings throughout our bikes so lubrication is not needed. The most important maintenance step is to simply wipe your perspiration off the bike after each use.

HOW DO I CLEAN MY HORIZON FITNESS UPRIGHT BIKE?

Clean with soap and water cleaners only. Never use solvents on plastic parts.

Cleanliness of your Horizon Fitness upright bike and its operating environment will keep maintenance problems and service calls to a minimum. For this reason, Horizon Fitness recommends that the following preventive maintenance schedule be followed.

AFTER EACH USE (DAILY)

- Unplug the power cord from the wall outlet.



WARNING!

To remove power from the upright bike, the power cord must be disconnected from the wall outlet.

- Never use solvents, as they can cause damage to the upright bike.
- Inspect the power cord. If the power cord is damaged, contact Horizon Fitness. (B52HR model only)
- Make sure the power cord is not underneath the upright bike or in any other area where it can become pinched or cut. (B52HR model only)

EVERY WEEK

Clean underneath the upright bike, following these steps:

- Unplug the power cord at the wall outlet. (B52HR model only)
- Move the upright bike to a remote location.
- Wipe or vacuum any dust particles or other objects that may have accumulated underneath the upright bike.
- Return the upright bike to its previous position.

EVERY MONTH

- Inspect all assembly bolts and pedals on the machine for proper tightness.

Your Horizon Fitness upright bike is designed to be reliable and maintenance free. However, if you do experience problems with your upright bike, please reference the troubleshooting guide listed below.

PROBLEM: There is no display on the console.

SOLUTION: Check the power supply connections at the wall outlet and the rear of the bike (B52HR model only) or batteries in the back of the console (B51 model only), also remove the console and verify that the console cable is attached properly, making sure that the cable is securely inserted into the console.

PROBLEM: The upright bike makes a squeaking or chirping noise.

SOLUTION: Loosen all bolts attached during the assembly process, grease the threads and tighten again.

PROBLEM: The resistance levels seem to be incorrect, seeming too hard or too easy.

SOLUTION: Reset the console and allow the resistance to reset to the default position. Restart the console and retry the resistance levels. (B52HR only)

Check your exercise environment for sources of interference such as high power lines, large motors, etc.

YOU MAY EXPERIENCE AN ERRATIC READOUT UNDER THE FOLLOWING CONDITIONS:

- Gripping the heart rate handlebars too tight. Try to maintain moderate pressure while holding onto the heart rate handlebars.
- Constant movement and vibration due to constantly holding the heart rate grips while exercising.
- When you are breathing heavily during a workout.
- When your hands are constricted by wearing a ring.
- When your hands are dry or cold. Try moistening your palms or rubbing them together to warm.
- Anyone with heavy arrhythmia.
- Anyone with arteriosclerosis or peripheral circulation disorder.
- Anyone whose skin on the measuring palms is especially thick.

Note: Outside interference sources such as computers, motors and fluorescent lights may cause the heart rate reading to be erratic.

If the above troubleshooting section does not remedy the problem, discontinue use and turn the power off.

DO NOT RETURN TO THE STORE, PLEASE
CONTACT THE HORIZON FITNESS CUSTOMER ASSISTANCE CENTER
TOLL-FREE @ 1-800-244-4192
Mon.-Fri., 8 a.m.-5 p.m. CST (excluding holidays).
www.horizonfitness.com

Common Product Questions

ARE THE SOUNDS MY UPRIGHT BIKE MAKES NORMAL?

Our upright bikes are some of the quietest available because they use belt drives and friction free magnetic resistance. We use the highest grade bearings and belts to minimize noise. However, because the resistance system itself is so quiet, you will occasionally hear other slight mechanical noises. Unlike older, louder technologies, there are no fans, friction belts, or alternator noises to mask these sounds on our upright bikes. These mechanical noises, which may or may not be intermittent, are normal and are caused by the transfer of significant amounts of energy to a rapidly spinning flywheel. All bearings, belts and other rotating parts will generate some noise which will transmit through the casing and frame. It is also normal for these sounds to change slightly during a workout and over time because of thermal expansion of the parts.

WHY IS THE UPRIGHT BIKE I HAD DELIVERED LOUDER THAN THE ONE AT THE STORE?

All fitness products seem quieter in a large store showroom because there is generally more background noise than in your home. Also, there will be less reverberation on a carpeted concrete floor than on a wood overlay floor. Sometimes a heavy rubber mat will help reduce reverberation through the floor. If a fitness product is placed close to a wall, there will be more reflected noise.

HOW LONG WILL THE DRIVE BELT LAST?

The computer modeling we have done indicated virtually thousands of maintenance free hours. Belts are now commonly used in far more demanding applications such as motorcycle drives.

CAN I MOVE THE UPRIGHT BIKE EASILY ONCE IT IS ASSEMBLED?

Your Horizon Fitness upright bike has a pair of transport wheels built into the front foot. It is easy to move your upright bike by rolling it on the front transport wheels. It is important that you place your Horizon Fitness upright bike in a comfortable and inviting room. Your upright bike is designed to use minimal floor space. Many people will place their upright bikes facing the TV or a picture window. If at all possible, avoid putting your upright bike in a unfinished basement. To make exercise a desirable daily activity for you, the upright bike should be in a attractive setting.

Conditioning Guidelines

Always consult your physician before beginning an exercise program.

HOW OFTEN?

The American Heart Association recommends that you exercise at least 3 to 4 days per week to maintain cardiovascular fitness. If you have other goals such as weight or fat loss, you will achieve your goal faster with more frequent exercise. Whether it's 3 days or 6 days, remember that your ultimate goal should be to make exercise a lifetime habit. Many people are successful staying with a fitness program if they set aside a specific time of day to exercise. It doesn't matter whether it's in the morning before your shower, during lunch hour or while watching the evening news. What's more important is that it's a time that allows you to keep a schedule, and a time when you won't be interrupted. If you are to be successful with your fitness program, you have to make it a priority in your life. So decide on a time, pull out your day planner and pencil in your exercise times for the next month!

HOW LONG?

For aerobic exercise benefits, it's recommended that you exercise from between 24 and 32 minutes per session. But start slowly and gradually increase your exercise times. If you've been sedentary during the past year, it may be a good idea to keep your exercise times to as little as five minutes initially. Your body will need time to adjust to the new activity. If your goal is weight loss, a longer exercise session at lower intensities has been found to be most effective. A workout time of 48 minutes or more is recommended for best weight loss results.

HOW HARD?

How hard you workout is also determined by your goals. If you use your Horizon Fitness upright bike to prepare for a 5K race, you will probably work out at a higher intensity than if your goal is general fitness. Regardless of your long term goals, always begin an exercise program at low intensity. Aerobic exercise does not have to be painful to be beneficial! There are two ways to measure your exercise intensity. The first is by monitoring your heart rate, and the second is by evaluating your perceived exertion level (this is simpler than it sounds!). Note: Always consult your physician before beginning an exercise program.

PERCEIVED EXERTION LEVEL

The second and simpler way to gauge your exercise intensity is to evaluate your perceived exertion level. While exercising if you are too winded to maintain a conversation without gasping, you are working out too hard. A good rule of thumb is to work to the point of exhilaration, not exhaustion. If you cannot catch your breath, it's time to slow down. Always be aware of other warning signs of overexertion.

Monitoring Your Heart Rate

FEEDBACK

Your Horizon Fitness upright bike offers two heart rate feedback options. You may choose to use the heart rate handlebars, or the chest transmitter for a hands free workout. (B52HR model only)

HEART RATE HANDLEBAR

Place the palm of your hands directly on the heart rate handlebars. Both hands must grip the bars for your heart rate to register. When gripping the handlebars, do not grip tightly. Holding the grips tightly may elevate your blood pressure. Try to maintain moderate pressure while holding onto the heart rate handlebars. It is recommended that you hold the handlebars only long enough to see your heart rate readout on the console. You may experience an erratic readout if consistently holding the handlebars.

If you have any problems with the heart rate function please refer to the troubleshooting section.



WARNING!

The heart rate function is not a medical device. Various factors may affect the accuracy of your heart rate reading. The heart rate reading is intended only as an exercise aid.

Heart Rate Chart

TARGET HEART RATE ZONE

Your 'Target Heart Rate Zone' is a percentage of your maximum heart rate. Target Zones will vary for each individual, depending on age, current level of conditioning, and personal fitness goals. The American Heart Association recommends working-out at a 'Target Heart Rate Zone' of between 60% and 75% of your maximum heart rate. See the chart below for convenient reference. **EXAMPLE** for a 42-year old user: find AGE along the bottom of the chart (round to 40), follow AGE column up to the TARGET ZONE BAR. RESULTS: 60% of maximum Hear Rate = 108 Beats Per Minute, 75% of maximum Heart Rate = 135 Beat Per Minute.

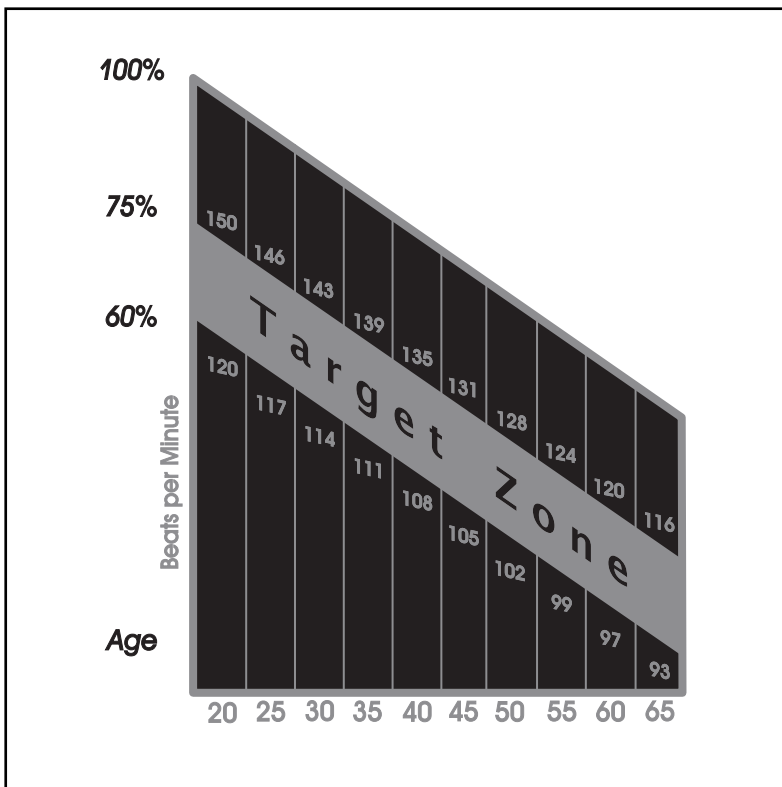

Developing Your Fitness Program

STRETCH FIRST

Before using your Horizon Fitness product, it is best to take a few minutes doing a few gentle stretching exercises. Stretching prior to exercise will improve flexibility and reduce chances of exercise related injury. Ease into each of these stretches with a slow gentle motion. Do not stretch to the point of pain. Make sure not to bounce while doing these stretches.

WALL PUSH

Stand near a wall with the toes of one foot about 18" from the wall, and the other foot about 12" behind the other foot. Lean forward, pushing against the wall with your palms. Keep your heels flat and hold this position for a count of 15 seconds. Make sure that you do not bounce while stretching. Alternate positions of your feet and repeat for a total of 8 repetitions.

STANDING QUADRICEPS STRETCH

Using a wall to provide balance, grasp your left ankle with your left hand and hold your foot against the back of your thigh for a count of 15 seconds. Repeat with your right ankle and hand, and continue alternating for a total of 8 repetitions.

SEATED TOE TOUCH

Sit on the floor with your legs together and straight out in front of you. Do not lock your knees. Extend your fingers towards your toes and hold for a count of 15 seconds. Make sure that you do not bounce while stretching. Sit upright again. Repeat for a total of 8 repetitions.

Warm Up & Cool Down

THE IMPORTANCE OF WARM UP AND COOL DOWN

WARM UP

The first 2 to 5 minutes of a workout should be devoted to warming up. The warm-up will limber your muscles and prepare them for more strenuous exercise. Make sure that you warm-up on your Horizon Fitness product at a slow pace.

COOL DOWN

Never stop exercising suddenly! A cool-down period allows your heart to readjust to the decreased demand. Make sure that your cool down period consists of a very slow pace to allow your heart rate to lower. After the cool-down, repeat the stretching exercises on page 28 to loosen and relax your muscles.

Achieving Your Fitness Goals

An important step in developing a long term fitness program is to determine your goals. Is your primary goal for exercising on your Horizon Fitness upright bike to lose weight? Improve muscle? Burn Stress? Prepare for the spring racing schedule? Knowing what your goals are will help you develop a more successful exercise program. Below are some common exercise goals:

- Weight Loss
- Improve Body Shape and Tone
- Increased Energy Level
- Improved Sports Performance
- Improved Cardiovascular Endurance
- Weight Maintenance
- Strengthen Leg Muscles
- Improved Sleep Patterns
- Stress Reduction

If possible try to define your personal goals in precise, measurable terms, and then put your goals in writing. The more specific you can be, the easier it will be to track your progress. If your goals are long term, divide them up into monthly and weekly segments. Longer term goals can lose some of the immediate motivation benefits. Short term goals are easier to achieve. Your Horizon Fitness upright bike console provides you with several readouts that can be used to record your progress. You can track Distance, Calories or Time. Time is the most important and useful of test functions.

KEEPING AN EXERCISE DIARY

Photocopy the weekly and monthly log sheets on the following pages to make your personal exercise log book. As time goes by you'll be able to look back with pride at the work you've done. As your fitness improves, you can look back and see how far you've come.

Weekly Log Sheets

WEEK # _____		WEEKLY GOAL: _____			
DAY	DATE	DISTANCE	CALORIES	TIME	COMMENTS
SUN					
MON					
TUES					
WED					
THUR					
FRI					
SAT					
WEEKLY TOTALS					

WEEK # _____		WEEKLY GOAL: _____			
DAY	DATE	DISTANCE	CALORIES	TIME	COMMENTS
SUN					
MON					
TUES					
WED					
THUR					
FRI					
SAT					
WEEKLY TOTALS					

WEEK # _____		WEEKLY GOAL: _____			
DAY	DATE	DISTANCE	CALORIES	TIME	COMMENTS
SUN					
MON					
TUES					
WED					
THUR					
FRI					
SAT					
WEEKLY TOTALS					

Monthly Log Sheets

MONTH _____		MONTHLY GOAL: _____	
WEEK #	DISTANCE	CALORIES	TIME
MONTHLY TOTALS			

MONTH _____		MONTHLY GOAL: _____	
WEEK #	DISTANCE	CALORIES	TIME
MONTHLY TOTALS			

MONTH _____		MONTHLY GOAL: _____	
WEEK #	DISTANCE	CALORIES	TIME
MONTHLY TOTALS			

Limited Warranty

FRAME • LIFETIME

Horizon Fitness warrants the frame against defects in workmanship and materials for the lifetime of the original owner.

BRAKE • 5 YEARS (B51) 10 YEARS (B52HR)

Horizon Fitness warrants the brake against defects in workmanship and materials for five years (B51), ten years (B52HR) of the original owner.

ELECTRONICS & PARTS • 1 YEAR

Horizon Fitness warrants the electronic components and all original parts for a period of one year from the date of original purchase, so long as the device remains in the possession of the original owner.

LABOR • 90 DAYS (B51) 1 YEAR (B52HR)

Horizon Fitness shall cover the labor cost for the repair of the device for a period of ninety days (B51), one year (B52HR) from the date of the original purchase, so long as the device remains in the possession of the original owner.

EXCLUSIONS AND LIMITATIONS

This warranty applies only to the original owner and is not transferable. This warranty is expressly limited to the repair or replacement of a defective frame, electronic component, or defective part and is the sole remedy of the warranty. The warranty does not cover normal wear and tear, improper assembly or maintenance, or installation of parts or accessories not originally intended or compatible with the upright bike as sold. The warranty does not apply to damage or failure due to accident, abuse, corrosion, discoloration of paint or plastic, or neglect. Horizon Fitness shall not be responsible for incidental or consequential damages. All returns must be pre-authorized by Horizon Fitness. Horizon Fitness' obligation under this warranty is limited to replacing or repairing, at Horizon Fitness' option, the product at one of its authorized service centers. An Horizon Fitness authorized service center must receive all products for which a warranty claim is made. These products must be received with all freight and other transportation charges prepaid, accompanied by sufficient proof of purchase. Parts and electronic components reconditioned to As New Condition by Horizon Fitness or its vendors may sometimes be supplied as warranty replacement parts and constitute fulfillment of warranty terms. This warranty gives you specific legal rights, and your rights may vary from state to state. This warranty is applicable to sales made only by Horizon Fitness, its affiliates, subsidiaries and authorized distributors of Horizon Fitness products within the U.S. and Canada.

WARRANTY REGISTRATION

Your warranty card must be completed and sent to Horizon Fitness or register on line at www.horizon-fitness.com, before a warranty claim can be processed.



Designed for life.™

HORIZON FITNESS | 800 BURTON BOULEVARD | DEFOREST, WI 53532
Phone 1-800-244-4192 Fax 1-608-842-1660
www.horizonfitness.com