

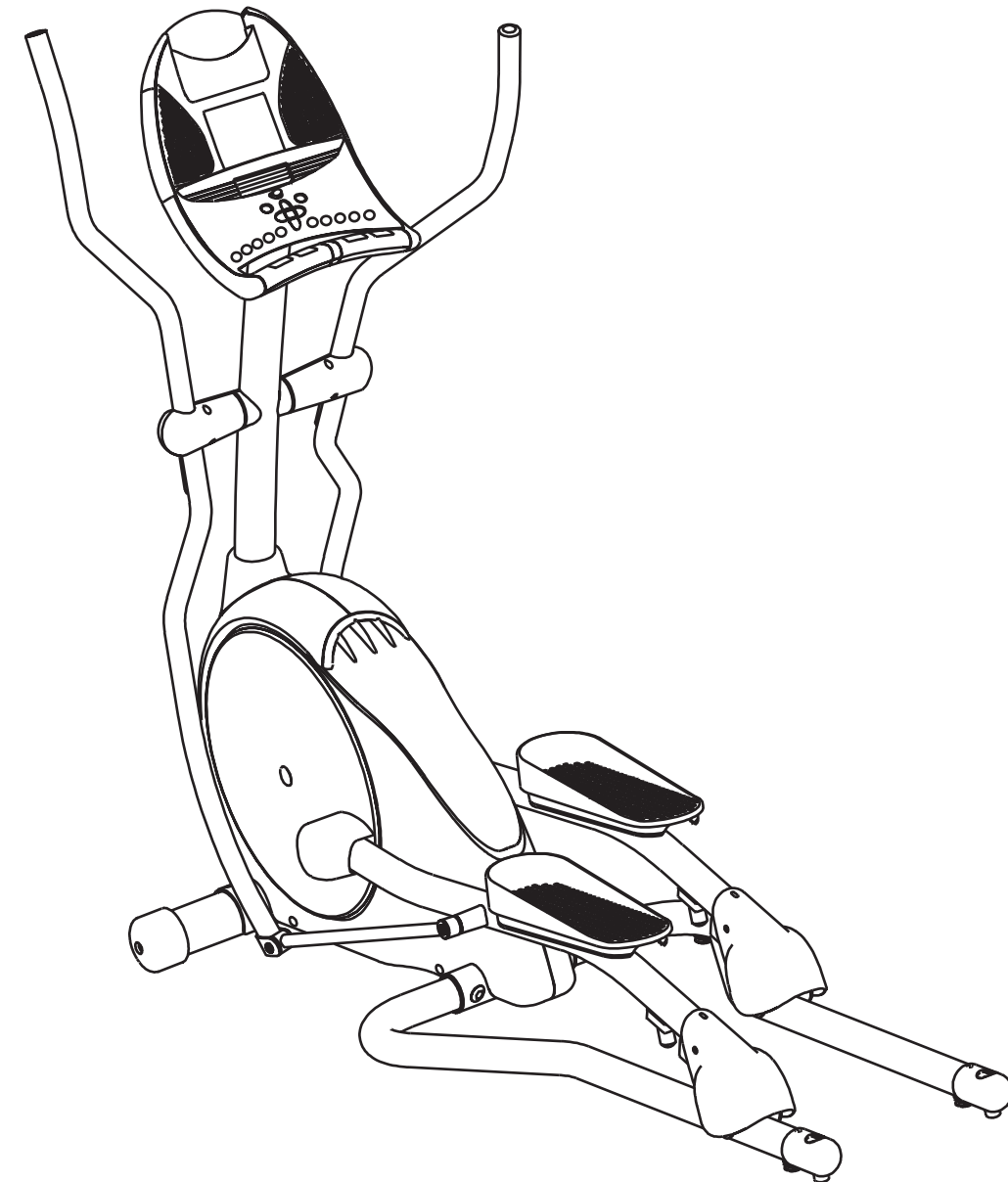

***SMEXE***



SMOOTH FITNESS | 800 BURTON BOULEVARD | DEFOREST, WI 53532  
Phone 1-800-244-4192 Fax 1-608-842-1660  
[www.smoothfitness.com](http://www.smoothfitness.com)

---

## ***Elliptical User's Guide***

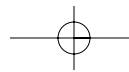
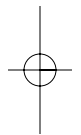
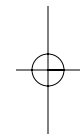
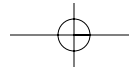

---

# Table of Contents

IMPORTANT PRECAUTIONS .....	3
BEFORE YOU BEGIN .....	7
ASSEMBLY .....	8
ELLIPTICAL OPERATION & ADJUSTMENT .....	11
CONSOLE FEATURES & DISPLAY .....	14
PROGRAM PROFILES .....	18
PROGRAM CHARTS .....	19
USING YOUR RACE PROGRAM .....	23
USING YOUR THR ZONE PROGRAMS 1 & 2 .....	24
USING YOUR CUSTOM USER PROGRAMS 1 & 2 .....	25
TROUBLESHOOTING & MAINTENANCE PROCEDURES .....	26
COMMON PRODUCT QUESTIONS .....	28
CONDITIONING GUIDELINES .....	30
MONITORING YOUR HEART RATE .....	31
HEART RATE CHART .....	32
WARM UP/COOL DOWN .....	33
DEVELOPING A FITNESS PROGRAM .....	34
ACHIEVING YOUR FITNESS GOALS .....	35
WEEKLY LOG SHEETS .....	37
MONTHLY LOG SHEETS .....	38
LIMITED WARRANTY .....	39



## CAUTION

Read all precautions and instructions in this manual before using this equipment.  
Save this manual for future reference.

---

## ***Important Precautions***

### **SAVE THESE INSTRUCTIONS**

When using an electrical product, basic precautions should always be followed. Read all instructions before using this exercise product.



### **WARNING!**

To reduce the risk of burns, fire, electrical shock or injury to persons:

- Use this exercise product for its intended use as described in this owner's guide. Do not use attachments not recommended by the manufacturer.
- Never drop or insert any object into any opening.
- Do not remove the elliptical trainer's side covers. Service should be performed only by an authorized Horizon Fitness service provider.
- Never operate this elliptical trainer if it has a damaged cord or plug, if it is not working properly, if it has been damaged, or immersed in water.
- Keep the cord away from heated surfaces.
- Do not use outdoors.
- Only use the power cord provided with your elliptical trainer.
- Never place the power cord under carpeting or place any object on top of the power cord, which may pinch or damage it.
- Unplug your elliptical trainer before moving it.

## Limited Warranty

### FRAME • LIFETIME

Horizon fitness warrants the frame against defects in workmanship and materials for the lifetime of the original owner.

### BRAKE • 12 YEARS

Horizon fitness warrants the brake against defects in workmanship and materials for twelve years of the original owner.

### ELECTRONICS & PARTS • 1 YEAR

Horizon Fitness warrants the electronic components and all original parts for a period of one year from the date of original purchase, so long as the device remains in the possession of the original owner.

### LABOR • 1 YEAR

Horizon Fitness shall cover the labor cost for the repair of the device for a period of one year from the date of the original purchase, so long as the device remains in the possession of the original owner.

### EXCLUSIONS AND LIMITATIONS

This warranty applies only to the original owner and is not transferable. This warranty is expressly limited to the repair or replacement of a defective frame, electronic component, or defective part and is the sole remedy of the warranty. The warranty does not cover normal wear and tear, improper assembly or maintenance, or installation of parts or accessories not originally intended or compatible with the elliptical trainer as sold. The warranty does not apply to damage or failure due to accident, abuse, corrosion, discoloration of paint or plastic, or neglect. Horizon Fitness shall not be responsible for incidental or consequential damages. All returns must be pre-authorized by Horizon Fitness. Horizon Fitness' obligation under this warranty is limited to replacing or repairing, at Horizon Fitness' option, the product at one of its authorized service centers. An Horizon Fitness authorized service center must receive all products for which a warranty claim is made. These products must be received with all freight and other transportation charges prepaid, accompanied by sufficient proof of purchase. Parts and electronic components reconditioned to As New Condition by Horizon Fitness or its vendors may sometimes be supplied as warranty replacement parts and constitute fulfillment of warranty terms. This warranty gives you specific legal rights, and your rights may vary from state to state. This warranty is applicable to sales made only by Horizon Fitness, its affiliates, subsidiaries and authorized distributors of Horizon Fitness products within the U.S. and Canada.

### OTHER SAFETY TIPS FOR YOUR ELLIPTICAL TRAINER



### CAUTION!

- If you experience chest pains, nausea, dizziness or shortness of breath, stop exercising immediately and consult your physician before continuing.
- Do not turn pedal arms by hand.
- Do not wear clothing that might catch on any part of the elliptical trainer.
- Make sure handlebars are secure before each use.
- Read the owner's guide before operating this elliptical trainer.
- Maintain a comfortable pace. Do not 'sprint' above 80 rpms on this machine.
- To maintain balance it is recommended to keep a grip on the handlebars while exercising, mounting or dismounting the machine.

### OPERATION

It is essential that your elliptical trainer is used only indoors, in a climate controlled room. If your elliptical trainer has been exposed to colder temperatures or high moisture climates, it is strongly recommended that the elliptical trainer is warmed up to room temperature before first time use. Failure to do so may cause premature electronic failure.

### CHILDREN

- Keep children off of your elliptical trainer at all times.
- When the elliptical is in use, young children and pets should be kept at least 10 feet away.

### CLEANING

- Clean with soap and slightly damp cloth only. Never use solvents.

### WEIGHT CAPACITY

- 275 lbs



**CAUTION:**

BEFORE BEGINNING ANY EXERCISE PROGRAM, ALWAYS CONSULT YOUR PHYSICIAN. IF YOU EXPERIENCE CHEST PAINS, NAUSEA, DIZZINESS OR SHORTNESS OF BREATH, STOP EXERCISING AND CONSULT YOUR PHYSICIAN BEFORE CONTINUING.

**IMPORTANT: PLEASE READ BEFORE USE!**

**ASSEMBLY**



**CAUTION!**

There are several areas during the assembly process of a elliptical trainer that special attention must be paid. It is very important to follow the assembly instructions correctly and to make sure all parts are firmly tightened. If the assembly instructions are not followed correctly, the elliptical trainer could have frame parts that are not tightened and will seem loose and may cause irritating noises. To prevent damage to the elliptical trainer, the assembly instructions must be reviewed and corrective actions should be taken.

# Monthly Log Sheet

MONTH _____		MONTHLY GOAL: _____	
WEEK #	DISTANCE	CALORIES	TIME
MONTHLY TOTALS			

MONTH _____		MONTHLY GOAL: _____	
WEEK #	DISTANCE	CALORIES	TIME
MONTHLY TOTALS			

MONTH _____		MONTHLY GOAL: _____	
WEEK #	DISTANCE	CALORIES	TIME
MONTHLY TOTALS			

# Weekly Log Sheet

WEEK # _____		WEEKLY GOAL: _____			
DAY	DATE	DISTANCE	CALORIES	TIME	COMMENTS
SUN					
MON					
TUES					
WED					
THUR					
FRI					
SAT					
WEEKLY TOTALS					

WEEK # _____		WEEKLY GOAL: _____			
DAY	DATE	DISTANCE	CALORIES	TIME	COMMENTS
SUN					
MON					
TUES					
WED					
THUR					
FRI					
SAT					
WEEKLY TOTALS					

WEEK # _____		WEEKLY GOAL: _____			
DAY	DATE	DISTANCE	CALORIES	TIME	COMMENTS
SUN					
MON					
TUES					
WED					
THUR					
FRI					
SAT					
WEEKLY TOTALS					

Before proceeding, find your elliptical trainer's serial number and model name located under the console mast boot and enter it in the space provided below:

**SERIAL NUMBER AND MODEL NAME LOCATION:**

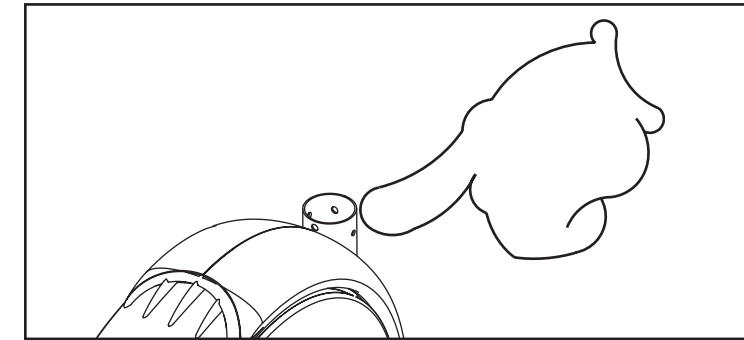

**ENTER YOUR SERIAL NUMBER IN BOX BELOW:**

Refer to this number when calling for service, and also enter this serial number on your Warranty Card and in your own records. Be sure to read the Safety Instructions and complete Owner's Guide before using your new elliptical trainer.

## Before You Begin

### CONGRATULATIONS!

 on choosing your elliptical trainer.

You've taken an important step in developing and sustaining an exercise program! Your elliptical trainer is a tremendously effective tool for achieving your personal fitness goals. Regular use of your elliptical trainer can improve the quality of your life in so many ways.

Here are just a few of the health benefits of aerobic exercise:

- Weight Loss
- A Healthier Heart
- Improved Muscle Tone
- Increased Daily Energy Levels
- Reduced Stress
- Help In Countering Anxiety and Depression
- An Improved Self Image

The key to reaping these benefits is to develop the exercise habit. Your new elliptical trainer will help you eliminate the obstacles that prevent you from getting in your exercise time. Inclement weather and darkness won't interfere with your workout when you use your elliptical trainer in the comfort of your home. This manual provides you with basic information for using and enjoying your new machine. A more complete knowledge of your new elliptical trainer will assist you in realizing your goal of a healthy lifestyle.

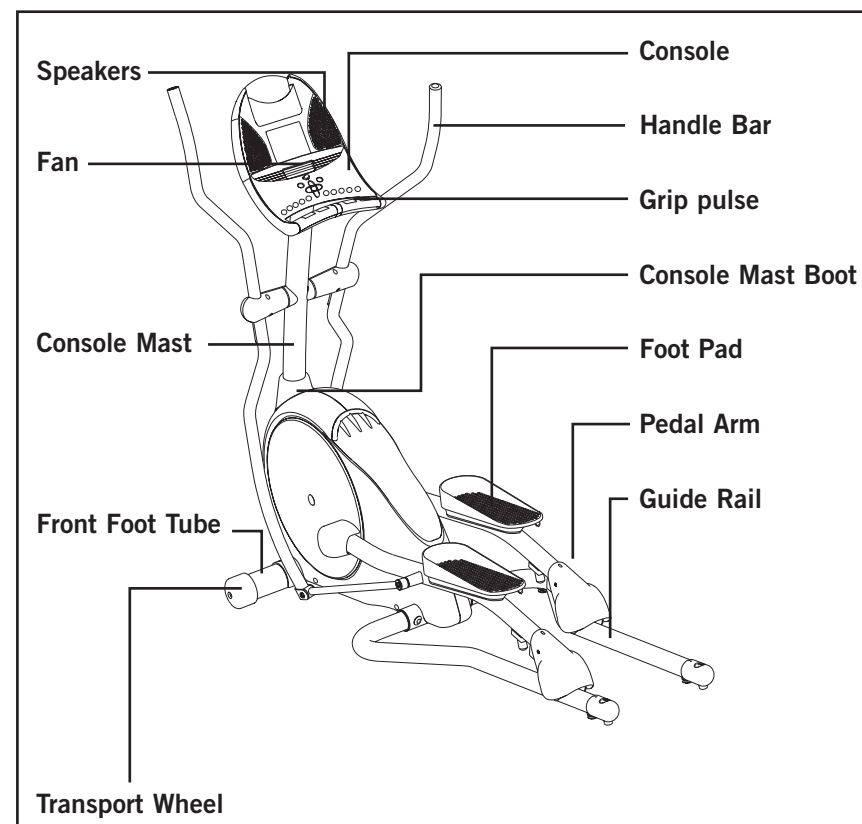

### KEEPING AN EXERCISE DIARY

Photocopy the weekly and monthly log sheets on the following pages to make your personal exercise log book. As time goes by you'll be able to look back with pride at the work you've done. As your fitness improves, you can look back and see how far you've come.

### HOW HARD?

How hard you workout is also determined by your goals. If you use your elliptical trainer to prepare for a 5K run, you will probably work out at a higher intensity than if your goal is general fitness. Regardless of your long term goals, always begin an exercise program at low intensity. Aerobic exercise does not have to be painful to be beneficial! There are two ways to measure your exercise intensity. The first is by monitoring your heart rate, and the second is by evaluating your perceived exertion level (this is simpler than it sounds!). Note: Always consult your physician before beginning an exercise program.

### PERCEIVED EXERTION LEVEL

The second and simpler way to gauge your exercise intensity is to evaluate your perceived exertion level. While exercising if you are too winded to maintain a conversation without gasping, you are working out too hard. A good rule of thumb is to work to the point of exhilaration, not exhaustion. If you cannot catch your breath, it's time to slow down. Always be aware of other warning signs of overexertion.



## Achieving Your Fitness Goals

An important step in developing a long term fitness program is to determine your goals. Is your primary goal for exercising on your elliptical trainer to lose weight? Improve muscle? Burn Stress? Prepare for the spring racing schedule? Knowing what your goals are will help you develop a more successful exercise program. Below are some common exercise goals:

- Weight Loss
- Improve Body Shape and Tone
- Increased Energy Level
- Improved Sports Performance
- Improved Cardiovascular Endurance
- Weight Maintenance
- Strengthen Leg Muscles
- Improved Sleep Patterns
- Stress Reduction

If possible try to define your personal goals in precise, measurable terms, and then put your goals in writing. The more specific you can be, the easier it will be to track your progress. If your goals are long term, divide them up into monthly and weekly segments. Longer term goals can lose some of the immediate motivation benefits. Short term goals are easier to achieve. Your elliptical trainer console provides you with several readouts that can be used to record your progress. You can track Distance, Calories or Time. Time is the most important and useful of test functions.

## Assembly

### UNPACKING

Unpack the product where you will be using it. Place the product on a level flat surface. It is recommended that you place a protective covering on your floor. **Note:** It is recommended that you apply grease to the threads of each bolt as you assemble the product, to prevent loosening and noise. Also, during each assembly step, ensure that ALL nuts and bolts are in place and partially threaded in before completely tightening any ONE bolt.

**FAILURE TO FOLLOW THESE INSTRUCTIONS COULD RESULT IN INJURY!** Place your elliptical trainer on a level flat surface. It is recommended that you place a protective covering on your floor.

### PARTS

- 1 Front Foot Tube
- 2 Upper Handlebars
- 2 Lower Handlebars
- 2 Pedal arms
- 2 Guide Rails
- 1 Console Mast
- 1 Console Mast Boot
- 1 Power Supply
- 1 Audio Wire
- 2 Crank Boots
- 2 Front Upper Handlebar Covers
- 2 Back Upper Handlebar Covers
- 2 Footpads
- 2 Pedal Link Arms
- 1 Hardware Pack

### TOOLS (included)

- 4mm Allen Wrench
- 5mm Allen Wrench/Phillips Screw Driver
- 13/15mm Flat Wrench
- 17mm Wrench

If you have any questions, or if there are any missing parts, we will guarantee complete satisfaction.

**PLEASE CALL OUR TOLL-FREE DIRECT CUSTOMER ASSISTANCE CENTER @ 1-800-244-4192  
Mon.-Fri., 8 a.m.-5 p.m. CST (excluding holidays).**

**HARDWARE**

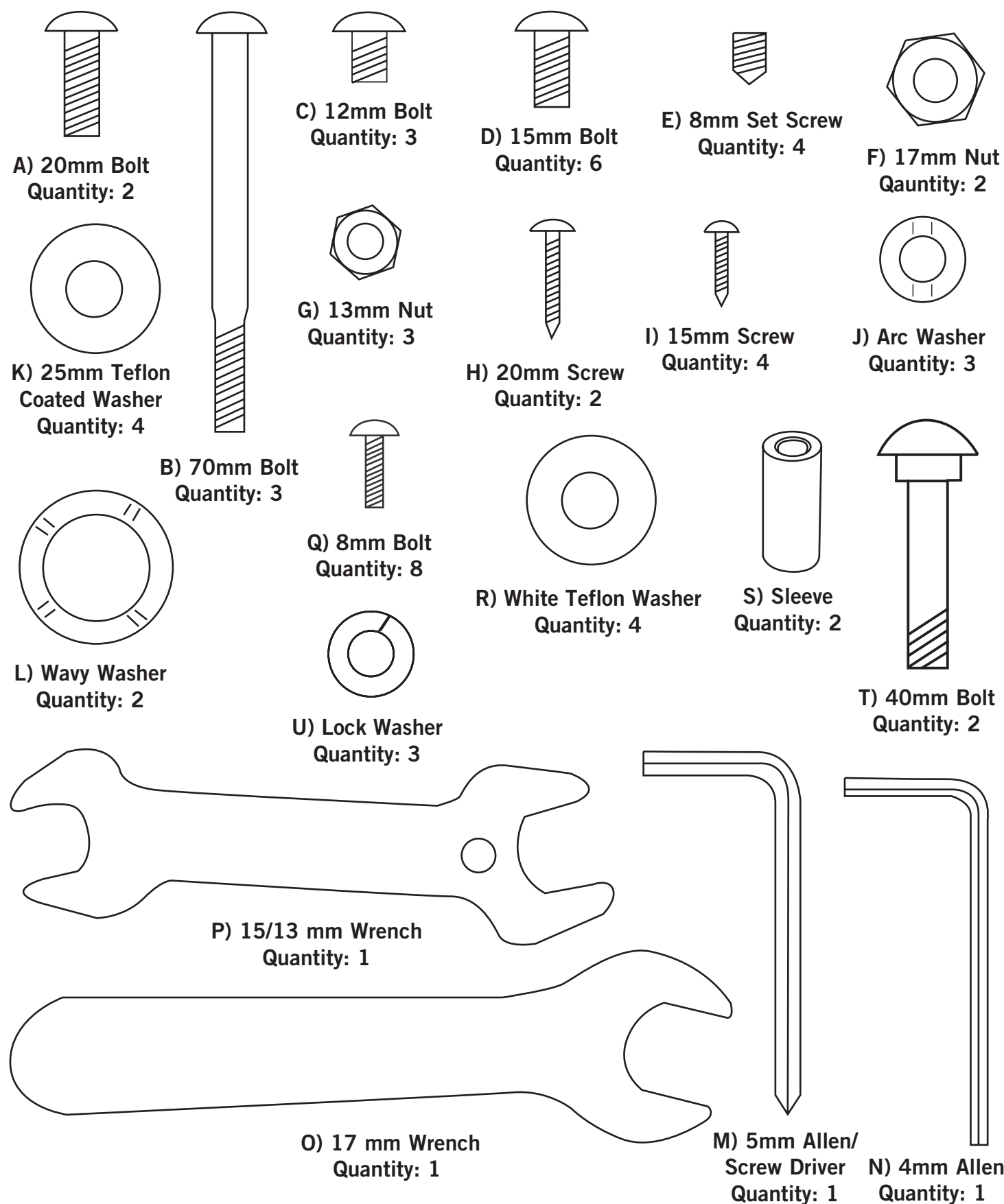

## Developing A Fitness Program

**STRETCH FIRST**

Before using your Horizon Fitness product, it is best to take a few minutes doing a few gentle stretching exercises. Stretching prior to exercise will improve flexibility and reduce chances of exercise related injury. Ease into each of these stretches with a slow gentle motion. Do not stretch to the point of pain. Make sure not to bounce while doing these stretches.

**WALL PUSH**

Stand near a wall with the toes of one foot about 18" from the wall, and the other foot about 12" behind the other foot. Lean forward, pushing against the wall with your palms. Keep your heels flat and hold this position for a count of 15 seconds. Make sure that you do not bounce while stretching. Alternate positions of your feet and repeat for a total of 8 repetitions.

**STANDING QUADRICEPS STRETCH**

Using a wall to provide balance, grasp your left ankle with your left hand and hold your foot against the back of your thigh for a count of 15 seconds. Repeat with your right ankle and hand, and continue alternating for a total of 8 repetitions.

**SEATED TOE TOUCH**

Sit on the floor with your legs together and straight out in front of you. Do not lock your knees. Extend your fingers towards your toes and hold for a count of 15 seconds. Make sure that you do not bounce while stretching. Sit upright again. Repeat for a total of 8 repetitions.

# Warm Up & Cool Down

## THE IMPORTANCE OF WARM UP AND COOL DOWN

### WARM UP

The first 2 to 5 minutes of a workout should be devoted to warming up. The warm-up will limber your muscles and prepare them for more strenuous exercise. Make sure that you warm-up on your Horizon Fitness product at a slow pace.

### COOL DOWN

Never stop exercising suddenly! A cool-down period allows your heart to readjust to the decreased demand. Make sure that your cool down period consists of a very slow pace to allow your heart rate to lower. After the cool-down, repeat the stretching exercises listed above to loosen and relax your muscles.

## ASSEMBLY STEPS

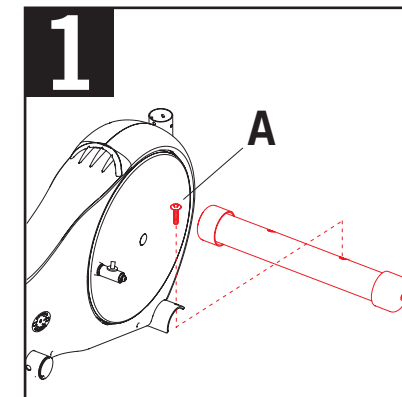

**STEP 1:**  
**ATTACH FRONT TUBE.**  
Note: Make sure not to tighten bolts until all assembly steps have been completely assembled and aligned.

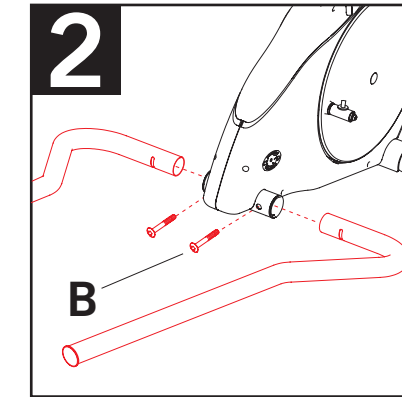

**STEP 2:**  
**ATTACH LEFT & RIGHT GUIDE RAILS.**

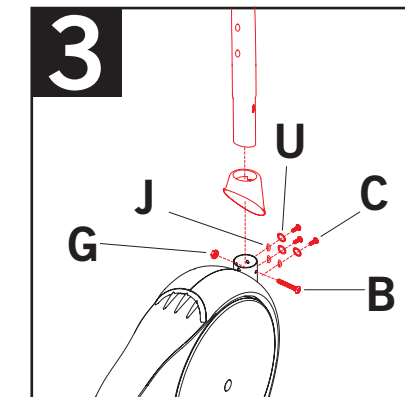

**STEP 3:**  
**ATTACH CONSOLE MAST AND CONSOLE MAST BOOT.**  
Note: Make sure to loosen the water bottle screws in order to fit the console cable through the mast. DO NOT PINCH WIRES!

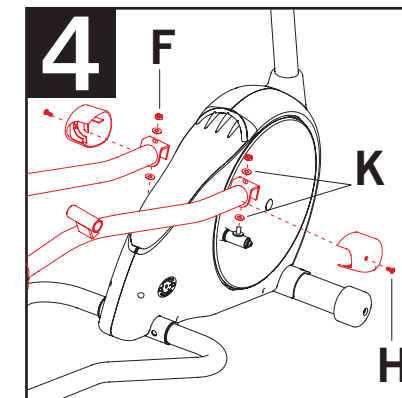

**STEP 4:**  
**ATTACH LEFT & RIGHT PEDAL ARMS AND PEDAL ARM SLEEVES.**  
Note: Black 'Teflon' surface of K should be facing the pedal arm.

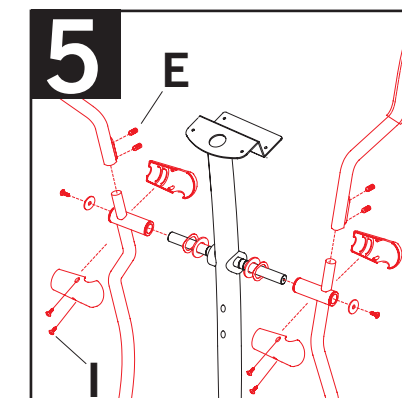

**STEP 5:**  
**ATTACH LEFT & RIGHT LOWER HANDLE BARS TO CONSOLE MAST. ATTACH LEFT & RIGHT UPPER HANDLE BARS. ATTACH H-BAR COVERS.** Note: Bolts and washers are pre-assembled.

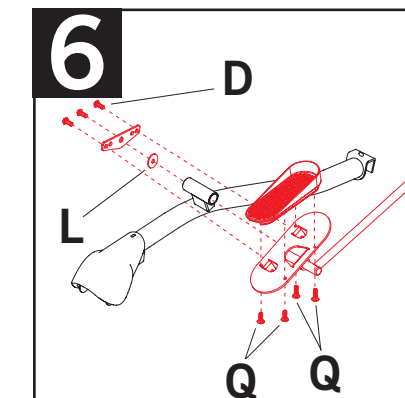

**STEP 6:**  
**ATTACH FOOT PAD TO FOOT PLATE THEN CONNECT THE PIVOTING FOOT PAD.**

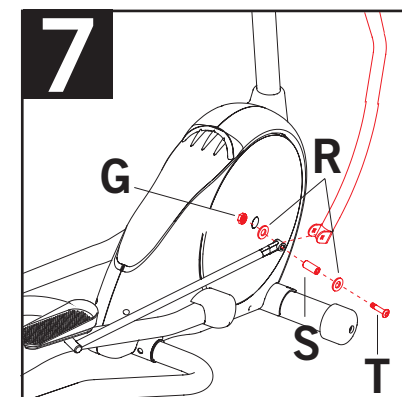

**STEP 7:**  
**ATTACH LEFT & RIGHT LINK ARMS TO LOWER LEFT & RIGHT HANDLE BARS.**

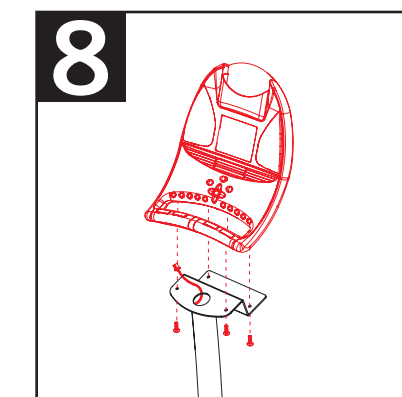

**STEP 8:**  
**ATTACH CONSOLE AND CONNECT ALL WIRES.**  
Note: DO NOT PINCH WIRES!  
Note: Bolts are pre-assembled to console.

## Elliptical Operation & Adjustment

### POWER

Your programmable elliptical trainer is powered by a power supply. The power supply must be plugged into the power jack, which is located in the front of the machine near the front foot tube.

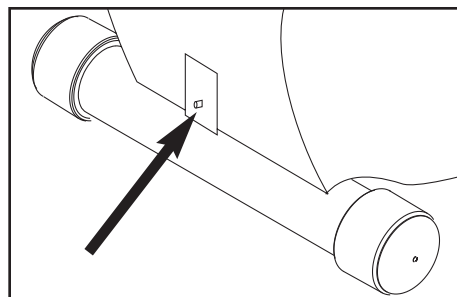

### LEVELING

The elliptical trainer should be level for optimum use. Once you have placed the elliptical trainer where you intend to use it, raise or lower the adjustable levelers located underneath each guiderail. Once you have leveled the elliptical trainer, lock the levelers in place by tightening the wing nuts against the frame.

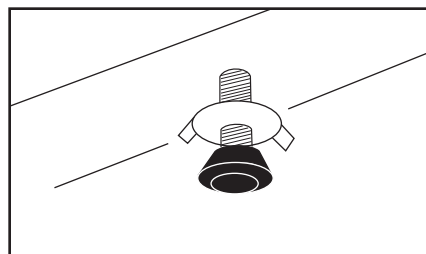

## Heart Rate Chart

### TARGET HEART RATE ZONE

Your 'Target Heart Rate Zone' is a percentage of your maximum heart rate. Target Zones will vary for each individual, depending on age, current level of conditioning, and personal fitness goals. The American Heart Association recommends working-out at a 'Target Heart Rate Zone' of between 60% and 75% of your maximum heart rate. See the chart below for convenient reference. **EXAMPLE** for a 42-year old user: find AGE along the bottom of the chart (round to 40), follow AGE column up to the TARGET ZONE BAR. RESULTS: 60% of maximum Hear Rate = 108 Beats Per Minute, 75% of maximum Heart Rate = 135 Beat Per Minute.

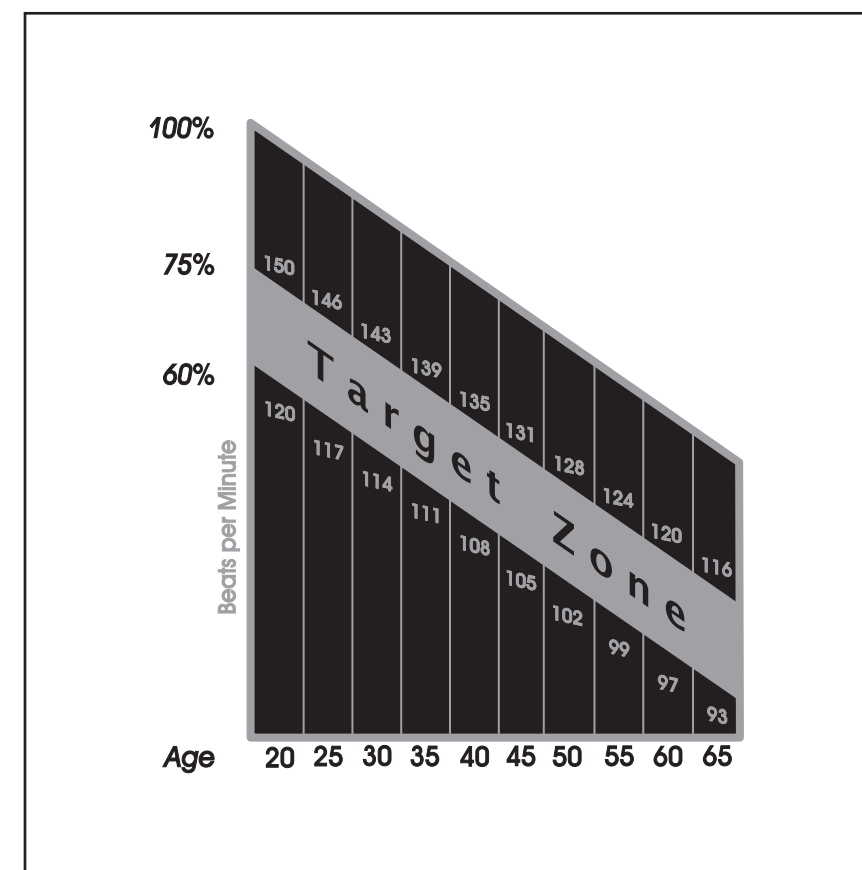

## Monitoring Your Heart Rate

### HEART RATE HANDLEBAR

Place the palm of your hands directly on the heart rate handlebars. Both hands must grip the bars for your heart rate to register. When gripping the handlebars, do not grip tightly. Holding the grips tightly may elevate your blood pressure. Try to maintain moderate pressure while holding onto the heart rate handlebars. It is recommended that you hold the handlebars only long enough to see your heart rate readout on the console. You may experience an erratic readout if consistently holding the handlebars.



### WARNING!

The heart rate function is not a medical device. Various factors may affect the accuracy of your heart rate reading. The heart rate reading is intended only as an exercise aid.

### MOVING

Your elliptical trainer has a pair of transport wheels built into the front of the frame. Carefully pick up the guide rails and roll the elliptical to the desired position.

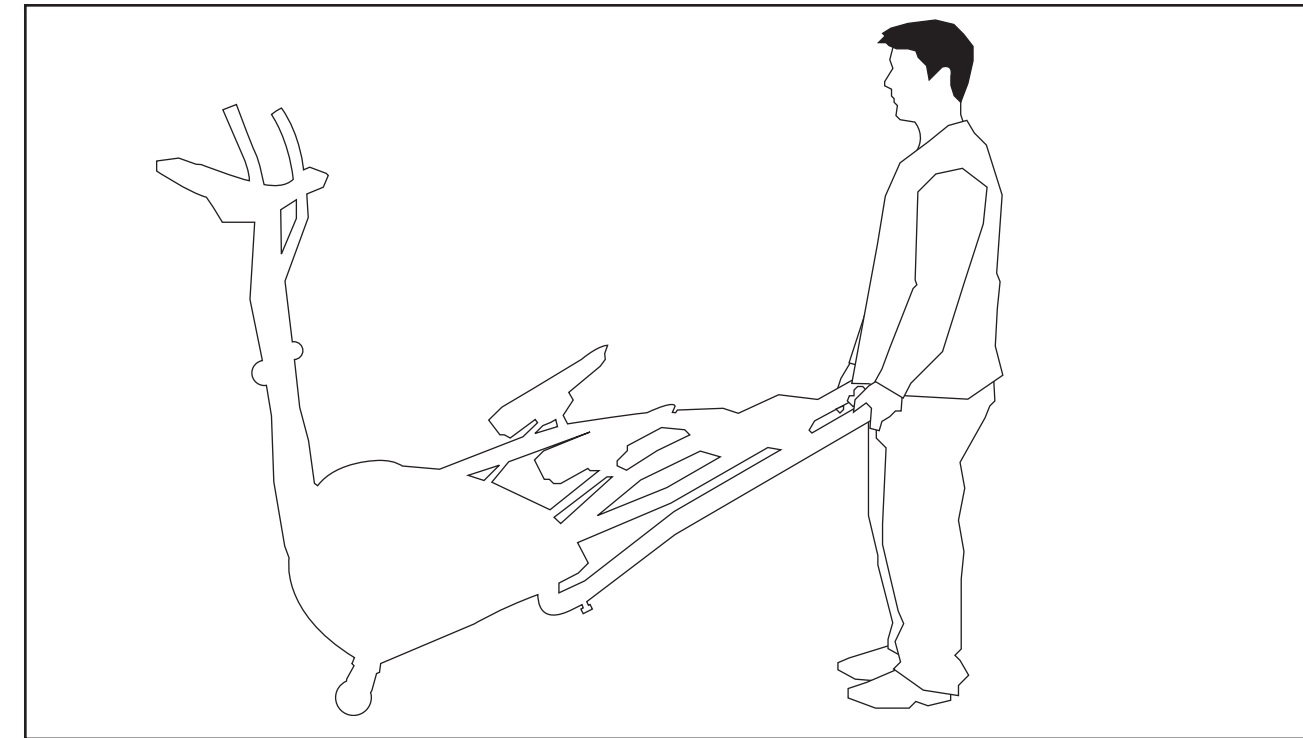



**CAUTION!** Our elliptical trainers are well built and heavy, weighing up to 200lbs.! Use care and additional help if necessary when moving.

#### **FOOT POSITIONING**

Your elliptical trainer has a variety of foot positions to offer a variance in your workout routine and to strengthen and train a wider range of leg muscles. Your elliptical trainer also allows you to pedal both forward and backwards to allow you to focus on other muscle groups such as hamstring and calves. When using your elliptical trainer, you may notice that your heel raises off of the foot pad. This is a natural walking or running motion and you should not try to prevent this.

---

## ***Conditioning Guidelines***

#### **IMPORTANT**

Always consult your physician before beginning an exercise program.



#### **HOW OFTEN?**

The American Heart Association recommends that you exercise at least 3 to 4 days per week to maintain cardiovascular fitness. If you have other goals such as weight or fat loss, you will achieve your goal faster with more frequent exercise. Whether it's 3 days or 6 days, remember that your ultimate goal should be to make exercise a lifetime habit. Many people are successful staying with a fitness program if they set aside a specific time of day to exercise. It doesn't matter whether it's in the morning before your shower, during lunch hour or while watching the evening news. What's more important is that it's a time that allows you to keep a schedule, and a time when you won't be interrupted. If you are to be successful with your fitness program, you have to make it a priority in your life. So decide on a time, pull out your day planner and pencil in your exercise times for the next month!

#### **HOW LONG?**

For aerobic exercise benefits, it's recommended that you exercise from between 24 and 32 minutes per session. But start slowly and gradually increase your exercise times. If you've been sedentary during the past year, it may be a good idea to keep your exercise times to as little as five minutes initially. Your body will need time to adjust to the new activity. If your goal is weight loss, a longer exercise session at lower intensities has been found to be most effective. A workout time of 48 minutes or more is recommended for best weight loss results.

**WHAT KIND OF ROUTINE MAINTENANCE IS REQUIRED?**

We use sealed bearings throughout our ellipticals so lubrication is not needed. The most important maintenance step is to simply wipe your perspiration off the entire trainer and guide rails after each use.

**HOW DO I CLEAN MY HORIZON FITNESS ELLIPTICAL TRAINER?**

Clean with soap and water cleaners only. Never use solvents on plastic parts.

Cleanliness of your elliptical trainer and its operating environment will keep maintenance problems and service calls to a minimum. For this reason, Horizon Fitness recommends that the following preventive maintenance schedule be followed:

**AFTER EACH USE**

Turn off the elliptical trainer with the on/off switch located on the back of the console, and unplug the power cord from the wall outlet.

**WARNING!**

To remove power from the elliptical, the power cord must be disconnected from the wall outlet.

- Clean the entire machine and guide rails
- Wipe down the elliptical trainer with a damp cloth. Never use solvents, as they can cause damage to the elliptical.
- Inspect the power cord. If the power cord is damaged, contact Horizon Fitness.
- Make sure the power cord is not underneath the elliptical trainer or in any other area where it can become pinched or cut.

**EVERY WEEK**

Clean underneath the elliptical, following these steps:

- Turn off the elliptical trainer with the on/off switch.
- Then unplug the power cord at the wall outlet.
- Move the elliptical trainer to a remote location.
- Wipe or vacuum any dust particles or other objects that may have accumulated underneath the elliptical.
- Return the elliptical trainer to its previous position.

**EVERY MONTH**

- Inspect all assembly bolts and pedals on the machine for proper tightness.

## Console Features & Display

**E54HR QUICK START UP**

Simply press the 'Start' button to begin exercising. The program will automatically default to the Manual program unless another program is selected.

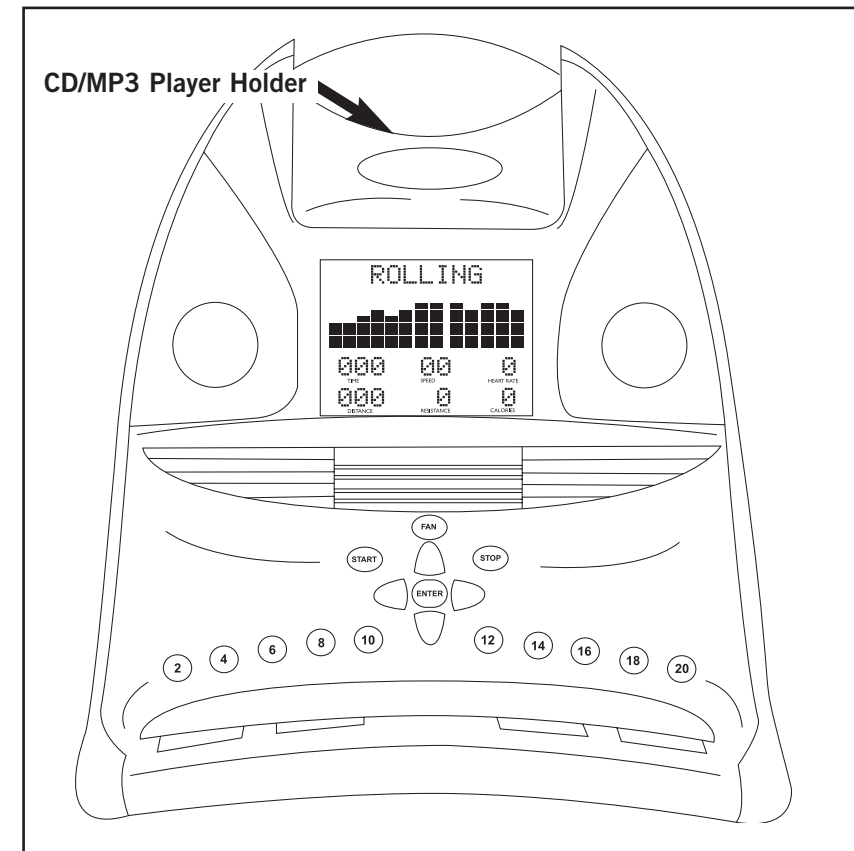
**RESET**

Press and hold the Stop button to reset the console.

**LOCATING THE SPEAKER INPUT JACK**

Compatible with CD/MP3, AM/FM and cassette, etc.

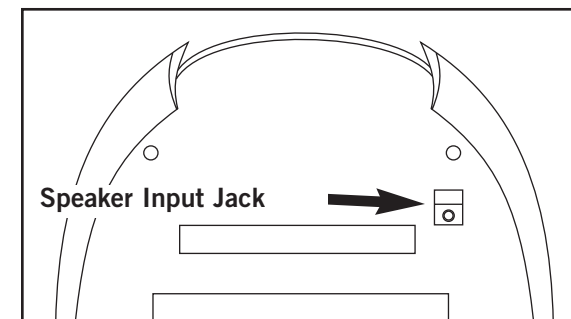

**TIME**

Shown as Minutes:Seconds. View the time remaining or the time elapsed in your workout.

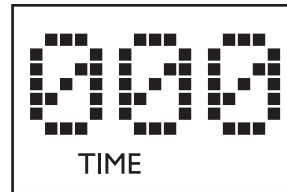
**DISTANCE**

Shown as Miles. View the accumulated distance during your workout.

**CALORIES**

Shown as total accumulated calories burned during your workout.

**RPM**

Shown as Revolutions per Minute. Improve striding technique while reducing leg muscle fatigue by striding between 60 & 70 RPM.



---

## *Common Product Questions*

**ARE THE SOUNDS MY ELLIPTICAL TRAINER MAKES NORMAL?**

Our elliptical trainers are some of the quietest available because they use belt drives and friction free magnetic resistance. We use the highest grade bearings and belts to minimize noise. However, because the resistance system itself is so quiet, you will occasionally hear other slight mechanical noises. Unlike older, louder technologies, there are no fans, friction belts, or alternator noises to mask these sounds on our elliptical trainers. These mechanical noises, which may or may not be intermittent, are normal and are caused by the transfer of significant amounts of energy to a rapidly spinning flywheel. All bearings, belts and other rotating parts will generate some noise which will transmit through the casing and frame. It is also normal for these sounds to change slightly during a workout and over time because of thermal expansion of the parts.

**WHY IS THE ELLIPTICAL TRAINER I HAD DELIVERED LOUDER THAN THE ONE AT THE STORE?**

All fitness products seem quieter in a large store showroom because there is generally more background noise than in your home. Also, there will be less reverberation on a carpeted concrete floor than on a wood overlay floor. Sometimes a heavy rubber mat will help reduce reverberation through the floor. If a fitness product is placed close to a wall, there will be more reflected noise.

**HOW LONG WILL THE DRIVE BELT LAST?**

The computer modeling we have done indicated virtually thousands of maintenance free hours. Belts are now commonly used in far more demanding applications such as motorcycle drives.

**CAN I MOVE THE TRAINER EASILY ONCE IT IS ASSEMBLED?**

Your elliptical trainer has a pair of transport wheels built into the front legs. It is easy to move your elliptical trainer by rolling it on the front transport wheels. It is important that you place your elliptical trainer in a comfortable and inviting room. Your elliptical trainer is designed to use minimal floor space. Many people will place their elliptical trainers facing the TV or a picture window. If at all possible, avoid putting your elliptical trainer in a unfinished basement. To make exercise a desirable daily activity for you, the elliptical trainer should be in a attractive setting.



**HEART RATE TROUBLESHOOTING**

**YOU MAY EXPERIENCE AN ERRATIC READOUT UNDER THE FOLLOWING CONDITIONS:**

- Gripping the heart rate handlebars too tight. Try to maintain moderate pressure while holding onto the heart rate handlebars.
- Constant movement and vibration due to constantly holding the heart rate grips while exercising.
- When you are breathing heavily during a workout.
- When your hands are constricted by wearing a ring.
- When your hands are dry or cold. Try moistening your palms or rubbing them together to warm.
- Anyone with heavy arrhythmia.
- Anyone with arteriosclerosis or peripheral circulation disorder.
- Anyone whose skin on the measuring palms is especially thick.

**Note:** Outside interference sources such as computers, motors and fluorescent lights may cause the heart rate reading to be erratic.

If the above troubleshooting section does not remedy the problem, discontinue use and turn the power off.

**DO NOT RETURN TO THE STORE, PLEASE**  
**CONTACT THE HORIZON FITNESS CUSTOMER ASSISTANCE CENTER**  
**TOLL-FREE @ 1-800-244-4192**  
**Mon.-Fri., 8 a.m.-5 p.m. CST (excluding holidays).**  
**[www.horizonfitness.com](http://www.horizonfitness.com)**

**RESISTANCE**

During a workout, the amount of resistance can be adjusted by pressing the plus 'Up' or 'Down' buttons or the quick resistance keys on the console. The resistance levels vary from level 1 to 20 quick speed keys (level 1 being the easiest and level 20 being the most difficult).



**WATTS**

A measurement of your expending energy. May be used to evaluate and quantify your fitness progress over time.

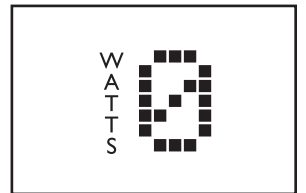

**HEART RATE**

Shown as Beats per Minute. You can monitor your heart rate at any time during your workout by holding the heart rate grips.

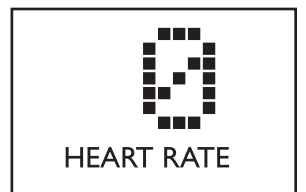

**PROFILE**

Allows you to view your program intensity while you exercise. Each horizontal row of bars represents 2 resistance levels.

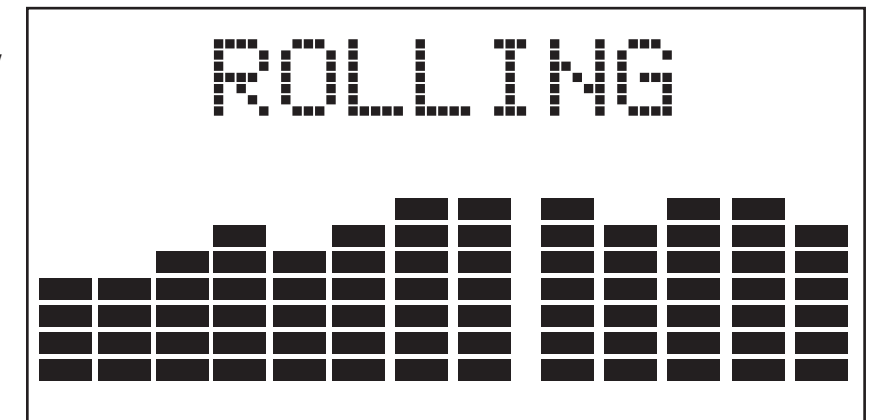

**CHOOSING A PROGRAM**

With the program text scrolling, press the arrow keys to scroll through the different programs. Press enter to choose your desired program. Once you choose your program, you will see the resistance level scrolling across the screen.

**CHOOSING A LEVEL**

With the level text scrolling, press the arrow keys to scroll through the different levels. Press 'ENTER' to choose your desired level. Once you choose your level, you will see the time scrolling across the screen.

**CHOOSING A RESISTANCE** (Manual Program)

With the resistance text scrolling, press the arrow keys or quick resistance keys to scroll through the different resistance levels. Press enter to choose your desired resistance. Once you choose your resistance, you will see the time scrolling across the screen.

**CHOOSING A TIME**

With the time text scrolling, press the arrow keys to scroll through the different times. Press enter to choose your desired time. Once you choose your time, press the 'Enter' button and begin your workout.

**CHOOSING YOUR WEIGHT**

With the weight text scrolling, press the arrow keys to scroll through the different weights. Press enter to choose your desired weight. Once you choose your weight, press the 'Start' button and begin your workout.

**FINISHING YOUR WORKOUT**

Press the 'Stop' button to pause your workout, press and hold to reset your workout. Remember to gradually slow down your pace before stopping or pausing your workout. The machine will not stop moving if you stop your feet abruptly. After you have finished your workout, the console will retain the data from your workout for 30 seconds before resetting.

---

## ***Troubleshooting & Maintenance Procedures***

Your elliptical trainer is designed to be reliable and maintenance free. However, if you do experience problems with your elliptical, please reference the troubleshooting guide listed below.

**TROUBLESHOOTING**

**PROBLEM:** There is no display on the console.

**SOLUTION:** Check all power cord and wire connections. Remove the console and verify that the console cable is attached properly, making sure that the cable is securely inserted into the console.

**PROBLEM:** The elliptical trainer makes a squeaking or chirping noise.

**SOLUTION:** Loosen all bolts attached during the assembly process, grease the threads and tighten again.

**PROBLEM:** The resistance levels seem to be incorrect, seeming too hard or too easy.

**SOLUTION:** Reset the console and allow the resistance to reset to the default position. Restart the console and retry the resistance levels.

**PROBLEM:** Roller wheels appear to be leaving particles on the guide rails.

**SOLUTION:** This is considered normal wear of the elliptical wheels. To remove, simply wipe off the roller wheels and guide rails with a damp cloth. Add silicon to guide rails.

## USING YOUR CUSTOM USER 1 & 2 PROGRAMS

Your Custom User 1 & 2 programs are designed to allow you to create your own programming, with the ability to save your program settings for future workouts. To use your Custom User 1 & 2 program, follow these instructions:

1. Once the Custom User 1 & 2 program has been selected, press 'Enter'.
2. Choose your desired time using the 'Up' or 'Down' button and press 'Enter'.
3. Choose your desired speed using the 'Up' or 'Down' button and press 'Enter'. You will need to select a speed for all 15 segments, pressing 'Enter' after each segment.
4. Once you have chosen your desired resistance level for all 15 segments, press 'Start' to begin your program. At this time, your program has been successfully saved into memory, and can be used for future workouts.
5. To reset your program information and delete it from memory, press and hold the 'Enter' button for 5 seconds once you have selected the Custom User 1 & 2 program in the start menu.
6. While using your saved program in the Custom User 1 & 2 program, you are able to adjust the resistance, but any changes will not be saved.

## Program Profiles

### P1 MANUAL

Customized workouts, allowing the user to adjust resistance level to the user's preference.

### P2 INTERVALS

Improves your strength, speed, and endurance by raising and lowering the resistance levels throughout your workout to involve both your heart and muscles.

### P3 ROLLING

Maintains weight by gradually raising and lowering the resistance level to gradually raise and lower your heart rate.

### P4 WEIGHT LOSS

Promotes weight loss by raising and lowering the resistance level, while keeping you in your fat burning zone.

### P5 TOUR

Simulates a gradual hill climb to strengthen your leg muscles and improve your cardiovascular health.

### P6 RACE

A great motivational program for competitive individuals that allows the user to compete with a computer pacer to the finish line.

### P7 THR ZONE 1

Benefits weight loss by maintaining an optimum exercise level to burn fat, while adjusting the resistance to keep you in your target heart rate zone.

### P8 THR ZONE 2

Benefits weight loss by maintaining an optimum exercise level to burn fat, while adjusting the resistance to keep you in your target heart rate zone.

### P9 CUSTOM USER PROGRAM 1

Customized workout, time defaults to 30 minutes.

### P10 CUSTOM USER PROGRAM 2

Customized workout, time defaults to 30 minutes.

# Program Charts

## P2 INTERVALS

Time-based goal with 10 difficulty levels to choose from.

Peak segments last 30 seconds, valley segments last 90 seconds.

Warm-up and cool-down last 5:00 minutes each and are included in program times.

Resistance	Warm Up		Program segments															Cool Down	
			1	2	3	4	5	6	7	8	9	10	11	12	13	14	15		
Level 1	1	1	2	5	2	5	2	5	2	5	2	5	2	5	2	5	2	1	1
Level 2	1	1	2	6	2	6	2	6	2	6	2	6	2	6	2	6	2	1	1
Level 3	1	2	3	7	3	7	3	7	3	7	3	7	3	7	3	7	3	2	1
Level 4	2	2	3	8	3	8	3	8	3	8	3	8	3	8	3	8	3	2	2
Level 5	2	2	4	9	4	9	4	9	4	9	4	9	4	9	4	9	4	2	2
Level 6	2	3	4	10	4	10	4	10	4	10	4	10	4	10	4	10	4	3	2
Level 7	2	3	5	11	5	11	5	11	5	11	5	11	5	11	5	11	5	3	2
Level 8	3	3	5	12	5	12	5	12	5	12	5	12	5	12	5	12	5	3	3
Level 9	3	3	6	13	6	13	6	13	6	13	6	13	6	13	6	13	6	3	3
Level 10	3	4	6	14	6	14	6	14	6	14	6	14	6	14	6	14	6	4	3

## USING YOUR THR ZONE 1 & 2 PROGRAMS

The THR zone program is designed to keep the user at an optimum exercise level, while adjusting the resistance levels to keep the user at a target heart rate. To choose the THR zone program, follow these instructions.

1. Choose the THR zone program by pressing the 'Up' or 'Down' buttons. Press 'Enter'.
2. Determine your target THR zone by using the heart rate chart (reference target heart rate THR zone chart in table of contents). Choose your target pulse zone by pressing the 'Up' or 'Down' buttons. Your target THR zone should be set at a number that you will be able to exercise throughout the majority of your workout.
3. The THR zone program will have a 5 minute warm-up period before it will start adjusting the resistance levels to get you to your target pulse zone.
4. After the 5 minute warm-up period, the resistance levels will increase gradually to get the user to the selected target THR zone. Once the user is at the target pulse zone; plus or minus 5 beats, the resistance level will remain at the current resistance level.
5. If the actual heart rate of the user is above the target THR zone, the resistance levels will gradually begin decreasing to keep the user in the target pulse zone. If the user is more than 25 beats above the target THR zone, the console will shut down for safety purposes.
6. The last 5 minutes of the program will be dedicated to a cool-down period. At this time, the program will gradually decrease the resistance level to give the user a smooth and easy cool down.

**Chest strap sold separately and for use with SMEXE model only.**

### CHEST STRAP TRANSMITTER PLACEMENT AND MOISTENING THE ELECTRODES

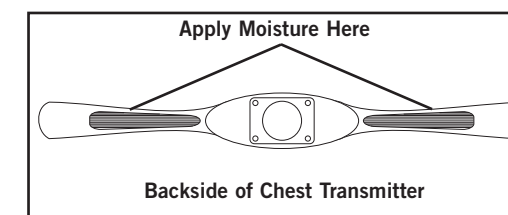
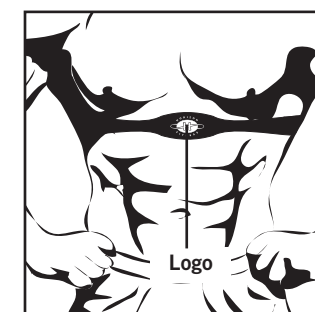

### USING YOUR RACE PROGRAM

Your Race Program is designed to add motivation to a workout by allowing you to compete against a selected pacer. To use your Race Program, follow these instructions:

1. Choose the Race program by either pressing the 'Up' or 'Down' buttons. Press 'Enter'.
  
2. Choose the desired Pace (average speed) using the 'Up' or 'Down' buttons. The Pace levels range from 2 mph to 22 mph in increments of .5 mph, with 2 mph being the lowest and 22 mph being the highest. Once the desired Pace is selected, press 'Enter'.
  
3. Choose the desired Distance by pressing the 'Up' or 'Down' buttons. Press 'Enter'.
  
4. Choose your weight by pressing the 'Up' or 'Down' buttons. Press 'Enter'.
  
5. Press 'Start' and begin your Race Program.

The time of the program will default accordingly to the pace (average speed) and distance that you entered. After the Race Program has started, press the 'Up' or 'Down' buttons or the quick resistance keys to adjust your resistance (levels 1-20). Your goal in this program is to beat the pacer to the finish line by covering an equal distance at a faster pace.

The top row of bars shows the computer pacer position. The bottom row of bars indicates your position. If you trail the pacer, you should pedal at a faster speed to catch and pass the pacer.

If you beat the pacer to the finish line, the screen will flash "You Win" and the program will end.  
 Note: If you beat the pacer to the finish line, you will complete the program before the projected finish time. If the pacer beats you to the finish line, the entire program time will elapse.

### P3 ROLLING

Time-based goal with 10 difficulty levels to choose from.

All segments last 10 seconds.

Warm-up and cool-down last 5:00 minutes each and are included in program times.

Resistance	Warm Up		Program segments															Cool Down	
			1	2	3	4	5	6	7	8	9	10	11	12	13	14	15		
Level 1	1	1	1	2	3	4	5	6	5	4	3	2	1	2	3	4	5	4	3
Level 2	1	2	2	3	4	5	6	7	6	5	4	3	2	3	4	5	6	5	3
Level 3	2	2	3	4	5	6	7	8	7	6	5	4	3	4	5	6	7	6	4
Level 4	2	3	4	5	6	7	8	9	8	7	6	5	4	5	6	7	8	7	4
Level 5	3	4	5	6	7	8	9	10	9	8	7	6	5	6	7	8	9	7	5
Level 6	3	5	6	7	8	9	10	11	10	9	8	7	6	7	8	9	10	8	5
Level 7	4	5	7	8	9	10	11	12	11	10	9	8	7	8	9	10	11	8	6
Level 8	4	6	8	9	10	11	12	13	12	11	10	9	8	9	10	11	12	9	6
Level 9	5	7	9	10	11	12	13	14	13	12	11	10	9	10	11	12	13	10	7
Level 10	5	8	10	11	12	13	14	15	14	13	12	11	10	11	12	13	14	11	7

### P4 WEIGHT LOSS

Time-based goal with 10 difficulty levels to choose from.

All segments last 10 seconds.

Warm-up and cool-down last 5:00 minutes each and are included in program times.

Resistance	Warm Up	Program segments															Cool Down	
		1	2	3	4	5	6	7	8	9	10	11	12	13	14	15		
Level 1	3 4	5	5	4	3	2	2	3	4	5	5	4	3	2	2	3	2	2
Level 2	3 5	6	6	5	4	3	3	4	5	6	6	5	4	3	3	4	3	2
Level 3	4 5	7	7	6	5	4	4	5	6	7	7	6	5	4	4	5	4	3
Level 4	4 6	8	8	7	6	5	5	6	7	8	8	7	6	5	5	6	5	3
Level 5	5 7	9	9	8	7	6	6	7	8	9	9	8	7	6	6	7	5	4
Level 6	5 8	10	10	9	8	7	7	8	9	10	10	9	8	7	7	8	6	4
Level 7	6 8	11	11	10	9	8	8	9	10	11	11	10	9	8	8	9	7	5
Level 8	6 9	12	12	11	10	9	9	10	11	12	12	11	10	9	9	10	8	5
Level 9	7 10	13	13	12	11	10	10	11	12	13	13	12	11	10	10	11	8	6
Level 10	7 11	14	14	13	12	11	11	12	13	14	14	13	12	11	11	12	9	6

### P5 TOUR

Distance-based program with 10 different difficulty levels to choose from.

Resistance	Warm Up	Program segments															Cool Down	Total distance			
		1	2	3	4	5	6	7	8	9	10	11	12	13	14	15					
Level 1	Resistance distance	2 142	2 212	3 283	4 256	3 113	5 387	3 91	4 351	5 333	4 301	5 301	3 165	5 288	3 434	4 312	4 310	3 150	2 113	2 300	4841
Level 2	Resistance distance	2 165	3 248	4 330	5 295	4 129	6 466	4 97	5 369	6 431	5 407	6 339	4 179	6 368	4 548	5 349	5 376	4 166	3 125	2 332	5718
Level 3	Resistance distance	3 169	4 253	5 337	6 308	5 142	7 484	6 97	7 389	8 441	7 413	8 349	6 187	8 376	6 560	7 373	6 383	5 172	4 129	3 344	5905
Level 4	Resistance distance	3 169	5 254	6 338	7 327	6 187	8 500	7 106	8 416	9 462	8 430	9 373	7 201	9 393	7 572	8 396	8 401	6 178	5 134	3 356	6192
Level 5	Resistance distance	4 170	5 254	7 339	8 256	7 113	9 387	8 91	9 351	10 333	9 433	10 375	8 205	11 405	9 575	10 400	9 410	8 180	7 135	5 360	5772
Level 6	Resistance distance	4 170	6 255	8 340	9 295	8 129	10 466	9 97	10 369	11 431	10 435	11 380	9 208	12 410	10 578	11 405	10 415	9 190	8 143	4 380	6096
Level 7	Resistance distance	5 171	7 256	9 341	10 308	9 142	11 484	10 97	11 389	12 441	11 435	12 380	10 210	13 415	11 580	12 410	11 425	10 200	9 150	5 400	6233
Level 8	Resistance distance	5 171	8 257	10 342	11 327	10 187	12 500	11 106	12 416	13 462	12 440	13 385	11 215	14 425	12 585	13 415	12 430	11 205	10 154	5 410	6431
Level 9	Resistance distance	6 172	8 257	11 343	12 327	11 187	13 500	12 106	13 416	14 462	13 450	14 390	12 220	15 460	14 590	15 420	14 435	13 210	12 158	6 420	6522
Level 10	Resistance distance	6 376	9 502	12 374	13 327	12 187	14 500	13 106	14 416	15 462	14 475	15 400	13 225	16 482	15 600	16 425	15 450	14 220	13 180	6 440	7147

Distance = Yards