

Get it fixed, at your home or ours!

Your Home

For repair—in your home—of all major brand appliances, lawn and garden equipment, or heating and cooling systems, **no matter who made it, no matter who sold it!**

For the replacement parts, accessories and owner's manuals that you need to do-it-yourself.

For Sears professional installation of home appliances and items like garage door openers and water heaters.

1-800-4-MY-HOME® (1-800-469-4663)

Call anytime, day or night (U.S.A. and Canada)

www.sears.com www.sears.ca

Our Home

For repair of carry-in items like vacuums, lawn equipment, and electronics, call or go on-line for the location of your nearest

Sears Parts & Repair Center.

1-800-488-1222

Call anytime, day or night (U.S.A. only)

www.sears.com

To purchase a protection agreement (U.S.A.) or maintenance agreement (Canada) on a product serviced by Sears:

1-800-827-6655 (U.S.A.)

1-800-361-6665 (Canada)

Para pedir servicio de reparación a domicilio, y para ordenar piezas:

1-888-SU-HOGARSM

(1-888-784-6427)

Au Canada pour service en français:

1-800-LE-FOYER^{MC}

(1-800-533-6937)

www.sears.ca

SEARS

© Registered Trademark / TM Trademark / SM Service Mark of Sears, Roebuck and Co.
© Marca Registrada / TM Marca de Fábrica / SM Marca de Servicio de Sears, Roebuck and Co.
^{MC} Marque de commerce / ^{MD} Marque déposée de Sears, Roebuck and Co.

© Sears, Roebuck and Co.

Rev. 1.0

REPAIR



CORE FITNESS SYSTEM

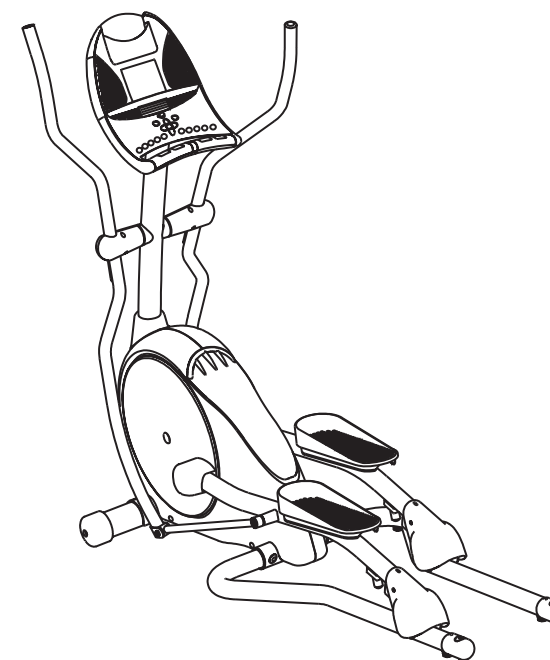

OWNER'S GUIDE

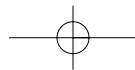
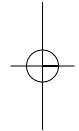
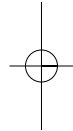
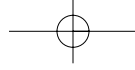

MONTHLY LOG SHEET

MONTH _____		MONTHLY GOAL: _____	
WEEK #	DISTANCE	CALORIES	TIME
MONTHLY TOTALS			

MONTH _____		MONTHLY GOAL: _____	
WEEK #	DISTANCE	CALORIES	TIME
MONTHLY TOTALS			

TABLE OF CONTENTS

SAFETY INSTRUCTIONS & WARRANTY	3
GETTING STARTED/POWER	7
FOLDING/UNFOLDING	8
MOVING/FOOT POSITION	9
KNOW YOUR ELLIPTICAL	10
QUICK START UP	11
PROGRAMMING	12
DISPLAY	13
CHOOSING A PROGRAM, RESISTANCE, TIME, WEIGHT & FINISH A WORKOUT	15
PROGRAM PROFILES	16
PROGRAM CHARTS	18
USING YOUR RACE PROGRAM	21
MONITORING YOUR HEART RATE & USING YOUR ADVENTURE PROGRAM	22
PULSE Zone™ CHART & PULSE Zone™ PROGRAM	23
TROUBLESHOOTING	24
COMMON PRODUCT QUESTIONS	26
EXERCISE GUIDELINES	27
ROUTINE MAINTENANCE	28
DEVELOPING A FITNESS PROGRAM & WARM UP & COOL DOWN	30
ACHIEVING YOUR FITNESS GOALS	31
WEEKLY LOG SHEET.....	32
MONTHLY LOG SHEET	33



CAUTION

Read all precautions and instructions in this manual before using this equipment.
Save this manual for future reference.

IMPORTANT SAFETY INSTRUCTIONS

SAVE THESE INSTRUCTIONS

When using an electrical product, basic precautions should always be followed. Read all instructions before using this exercise product.



WARNING!

To reduce the risk of burns, fire, electrical shock or injury to persons:

- Use this exercise product for its intended use as described in this owner's guide. Do not use attachments not recommended by the manufacturer.
- Never drop or insert any object into any opening.
- Do not remove the elliptical trainer's side covers. Service should be performed only by an authorized service provider.
- Never operate this elliptical trainer if it has a damaged cord or plug, if it is not working properly, if it has been damaged, or immersed in water.
- Keep the cord away from heated surfaces.
- Do not use outdoors.
- Only use the power cord provided with your elliptical trainer.
- Never place the power cord under carpeting or place any object on top of the power cord, which may pinch or damage it.
- Unplug your elliptical trainer before moving it.

WEEKLY LOG SHEET

WEEK # _____		WEEKLY GOAL: _____			
DAY	DATE	DISTANCE	CALORIES	TIME	COMMENTS
SUN					
MON					
TUES					
WED					
THUR					
FRI					
SAT					
WEEKLY TOTALS					

WEEK # _____		WEEKLY GOAL: _____			
DAY	DATE	DISTANCE	CALORIES	TIME	COMMENTS
SUN					
MON					
TUES					
WED					
THUR					
FRI					
SAT					
WEEKLY TOTALS					

ACHIEVING YOUR FITNESS GOALS

An important step in developing a long term fitness program is to determine your goals. Is your primary goal for exercising on your elliptical trainer to lose weight? Improve muscle? Burn Stress? Prepare for the spring racing schedule? Knowing what your goals are will help you develop a more successful exercise program. Below are some common exercise goals:

- Weight Loss
- Improve Body Shape and Tone
- Increased Energy Level
- Improved Sports Performance
- Improved Cardiovascular Endurance
- Weight Maintenance
- Strengthen Leg Muscles
- Improved Sleep Patterns
- Stress Reduction

If possible try to define your personal goals in precise, measurable terms, and then put your goals in writing. The more specific you can be, the easier it will be to track your progress. If your goals are long term, divide them up into monthly and weekly segments. Longer term goals can lose some of the immediate motivation benefits. Short term goals are easier to achieve. Your elliptical trainer console provides you with several readouts that can be used to record your progress. You can track Distance, Calories or Time. Time is the most important and useful of test functions.

KEEPING AN EXERCISE DIARY

Photocopy the weekly and monthly log sheets on the following pages to make your personal exercise log book. As time goes by you'll be able to look back with pride at the work you've done. As your fitness improves, you can look back and see how far you've come.

OTHER SAFETY TIPS FOR YOUR ELLIPTICAL TRAINER

TIPS

CAUTION!

- If you experience chest pains, nausea, dizziness or shortness of breath, stop exercising immediately and consult your physician before continuing.
- Do not turn pedal arms by hand.
- Do not wear clothing that might catch on any part of the elliptical trainer.
- Make sure handlebars are secure before each use.
- Read the owner's guide before operating this elliptical trainer.
- Maintain a comfortable pace. Do not 'sprint' above 80 rpms on this machine.
- To maintain balance it is recommended to keep a grip on the handlebars while exercising, mounting or dismounting the machine.

OPERATION

It is essential that your elliptical trainer is used only indoors, in a climate controlled room. If your elliptical trainer has been exposed to colder temperatures or high moisture climates, it is strongly recommended that the elliptical trainer is warmed up to room temperature before first time use. Failure to do so may cause premature electronic failure.

CHILDREN

- Keep children off of your elliptical trainer at all times.
- When the elliptical is in use, young children and pets should be kept at least 10 feet away.

CLEANING

- Clean with soap and slightly damp cloth only. Never use solvents.

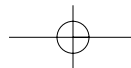

CONGRATULATIONS! on choosing an elliptical trainer.

You've taken an important step in developing and sustaining an exercise program! Your elliptical trainer is a tremendously effective tool for achieving your personal fitness goals. Regular use of your elliptical trainer can improve the quality of your life in so many ways.

Here are just a few of the health benefits of aerobic exercise:

- Weight Loss
- A Healthier Heart
- Improved Muscle Tone
- Increased Daily Energy Levels
- Reduced Stress
- Help In Countering Anxiety and Depression
- An Improved Self Image

The key to reaping these benefits is to develop the exercise habit. Your new elliptical trainer will help you eliminate the obstacles that prevent you from getting in your exercise time. Inclement weather and darkness won't interfere with your workout when you use your elliptical trainer in the comfort of your home. This manual provides you with basic information for using and enjoying your new machine. A more complete knowledge of your new elliptical trainer will assist you in realizing your goal of a healthy lifestyle.



CAUTION: BEFORE BEGINNING ANY EXERCISE PROGRAM, ALWAYS CONSULT YOUR PHYSICIAN. IF YOU EXPERIENCE CHEST PAINS, NAUSEA, DIZZINESS OR SHORTNESS OF BREATH, STOP EXERCISING AND CONSULT YOUR PHYSICIAN BEFORE CONTINUING.

IMPORTANT: PLEASE READ BEFORE USE!

ASSEMBLY

CAUTION! There are several areas during the assembly process of a elliptical trainer that special attention must be paid. It is very important to follow the assembly instructions correctly and to make sure all parts are firmly tightened. If the assembly instructions are not followed correctly, the elliptical trainer could have frame parts that are not tightened and will seem loose and may cause irritating noises. To prevent damage to the elliptical trainer, the assembly instructions must be reviewed and corrective actions should be taken.

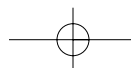

DEVELOPING A FITNESS PROGRAM

STRETCH FIRST

Before using your Sears product, it is best to take a few minutes doing a few gentle stretching exercises. Stretching prior to exercise will improve flexibility and reduce chances of exercise related injury. Ease into each of these stretches with a slow gentle motion. Do not stretch to the point of pain. Make sure not to bounce while doing these stretches.

WALL PUSH

Stand near a wall with the toes of one foot about 18" from the wall, and the other foot about 12" behind the other foot. Lean forward, pushing against the wall with your palms. Keep your heels flat and hold this position for a count of 15 seconds. Make sure that you do not bounce while stretching. Alternate positions of your feet and repeat for a total of 8 repetitions.

STANDING QUADRICEPS STRETCH

Using a wall to provide balance, grasp your left ankle with your left hand and hold your foot against the back of your thigh for a count of 15 seconds. Repeat with your right ankle and hand, and continue alternating for a total of 8 repetitions.

SEATED TOE TOUCH

Sit on the floor with your legs together and straight out in front of you. Do not lock your knees. Extend your fingers towards your toes and hold for a count of 15 seconds. Make sure that you do not bounce while stretching. Sit upright again. Repeat for a total of 8 repetitions.

THE IMPORTANCE OF WARM UP AND COOL DOWN

WARM UP

The first 2 to 5 minutes of a workout should be devoted to warming up. The warm-up will limber your muscles and prepare them for more strenuous exercise. Make sure that you warm-up on your elliptical trainer at a slow pace.

COOL DOWN

Never stop exercising suddenly! A cool-down period allows your heart to readjust to the decreased demand. Make sure that your cool down period consists of a very slow pace to allow your heart rate to lower. After the cool-down, repeat the stretching exercises listed above to loosen and relax your muscles.

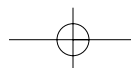

HOW HARD?

How hard you workout is also determined by your goals. If you use your elliptical trainer to prepare for a 5K run, you will probably work out at a higher intensity than if your goal is general fitness. Regardless of your long term goals, always begin an exercise program at low intensity. Aerobic exercise does not have to be painful to be beneficial! There are two ways to measure your exercise intensity. The first is by monitoring your heart rate, and the second is by evaluating your perceived exertion level (this is simpler than it sounds!). Note: Always consult your physician before beginning an exercise program.

PERCEIVED EXERTION LEVEL

The second and simpler way to gauge your exercise intensity is to evaluate your perceived exertion level. While exercising if you are too winded to maintain a conversation without gasping, you are working out too hard. A good rule of thumb is to work to the point of exhilaration, not exhaustion. If you cannot catch your breath, it's time to slow down. Always be aware of other warning signs of overexertion.

Before proceeding, find your elliptical trainer's serial number and model name located under the console mat boot and enter it in the space provided below:

SERIAL NUMBER AND MODEL NAME LOCATION:

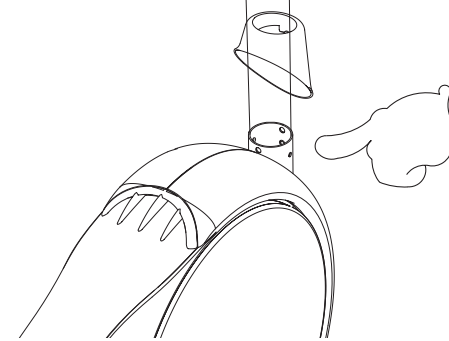

ENTER YOUR SERIAL NUMBER IN BOX BELOW:

Refer to this number when calling for service, and also enter this serial number on your Warranty Card and in your own records. Be sure to read the Safety Instructions and complete Owner's Guide before using your new elliptical trainer.

WARRANTY REGISTRATION

Your warranty card must be completed and sent to Sears within thirty days of purchase or registered on line at www.sears.com, before a warranty claim can be processed. Please keep receipt with owner's guide as it may be required for a warranty claim. Make sure to send in warranty registration card to validate your warranty.

ONE YEAR FULL WARRANTY ON PARTS AND LABOR

Contact Sears at 1-800-4-MY-HOME® to arrange to have it repaired free of charge.

Sears, Roebuck and Co., Dept. 817WA, Hoffman Estates, IL 60179

GETTING STARTED

POWER

Your programmable elliptical trainer is powered by a power supply. The power supply must be plugged into the power jack, which is located in the front of the machine near the front foot tube.

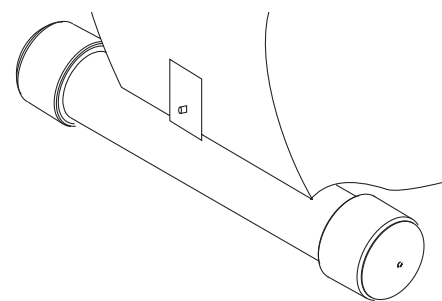

LEVELING

The elliptical trainer should be level for optimum use. Once you have placed the elliptical trainer where you intend to use it, raise or lower the adjustable levelers located on the outside of each pedal arm. Once you have leveled the elliptical trainer, lock the levelers in place by tightening the wing nuts against the frame.

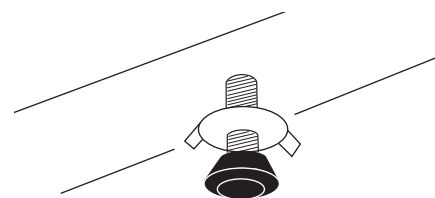

ROUTINE MAINTENANCE

WHAT KIND OF ROUTINE MAINTENANCE IS REQUIRED?

We use sealed bearings throughout our ellipticals so lubrication is not needed. The most important maintenance step is to simply wipe your perspiration off the trainer after each use.

HOW DO I CLEAN MY ELLIPTICAL TRAINER?

Clean with soap and water cleaners only. Never use solvents on plastic parts.

Cleanliness for your elliptical trainer and its operating environment will keep maintenance problems and service calls to a minimum. For this reason, it is recommended that the following preventive maintenance schedule be followed.

TIPS

AFTER EACH USE (DAILY)

Unplug the power cord from the wall outlet.

WARNING!

To remove power from the elliptical trainer, the power cord must be disconnected from the wall outlet.

- Wipe down the elliptical trainer with a damp cloth. Never use solvents, as they can cause damage to the elliptical.
- Inspect the power cord. If the power cord is damaged, contact Sears.
- Make sure the power cord is not underneath the elliptical trainer or in any other area where it can become pinched or cut.

EVERY WEEK

Clean underneath the Elliptical, following these steps:

- Fold Elliptical to its upright position. Make sure the Elliptical pedal arms are secure before running.
- Unplug the power cord at the wall outlet.
- Move the elliptical trainer to a remote location.
- Wipe or vacuum any dust particles or other objects that may have accumulated underneath the Elliptical.
- Return the elliptical trainer to its previous position.

EVERY MONTH

- Inspect all assembly bolts and pedals on the machine for proper tightness.

EXERCISE GUIDELINES

Always consult your physician before beginning an exercise program.

HOW OFTEN?

The American Heart Association recommends that you exercise at least 3 to 4 days per week to maintain cardiovascular fitness. If you have other goals such as weight or fat loss, you will achieve your goal faster with more frequent exercise. Whether it's 3 days or 6 days, remember that your ultimate goal should be to make exercise a lifetime habit. Many people are successful staying with a fitness program if they set aside a specific time of day to exercise. It doesn't matter whether it's in the morning before your shower, during lunch hour or while watching the evening news. What's more important is that it's a time that allows you to keep a schedule, and a time when you won't be interrupted. If you are to be successful with your fitness program, you have to make it a priority in your life. So decide on a time, pull out your day planner and pencil in your exercise times for the next month!

HOW LONG?

For aerobic exercise benefits, it's recommended that you exercise from between 24 and 32 minutes per session. But start slowly and gradually increase your exercise times. If you've been sedentary during the past year, it may be a good idea to keep your exercise times to as little as five minutes initially. Your body will need time to adjust to the new activity. If your goal is weight loss, a longer exercise session at lower intensities has been found to be most effective. A workout time of 48 minutes or more is recommended for best weight loss results.

FOLDING YOUR ELLIPTICAL TRAINER

Note: It is important to always follow the correct order of steps when folding your elliptical trainer.

STEP 1: The first step is to position the elliptical pedal arms in the proper position. The pedal arms can be positioned in two different positions for convenience. The first position is to rotate the left pedal arm so that it is in the backmost position (the left pedal arm wheel should be positioned at the rear of the elliptical trainer). The second position would be to rotate the right pedal arm in the backmost position.

STEP 2: Carefully raise both the pedal arm (in the backmost position) and guide rail simultaneously.

STEP 3: Press and hold the lock latch button located underneath the guide rail end cap. Align the lock latch with the lock latch receiver located underneath the pedal arm. Insert the lock latch receiver into the lock latch. Release the lock latch button once the lock latch is secure.

STEP 4: Repeat process for alternate side.

UNFOLDING YOUR ELLIPTICAL TRAINER

Note: It is important to always follow the correct order of steps when unfolding your elliptical trainer.

STEP 1: Firmly grasp both the left pedal arm and guide rail. Press and release the lock latch receiver from the lock latch. Carefully lower the pedal arm and guide rail, standing to the side to avoid any accidental release of the alternate pedal arm and guide rail.

STEP 2: Repeat process for alternate side.

MOVING

Your elliptical trainer has a pair of transport wheels built into the front of the frame. With the Elliptical in the folded position and bracing one foot against the front foot tube, carefully pull back on the console mast and roll the elliptical to the desired position.

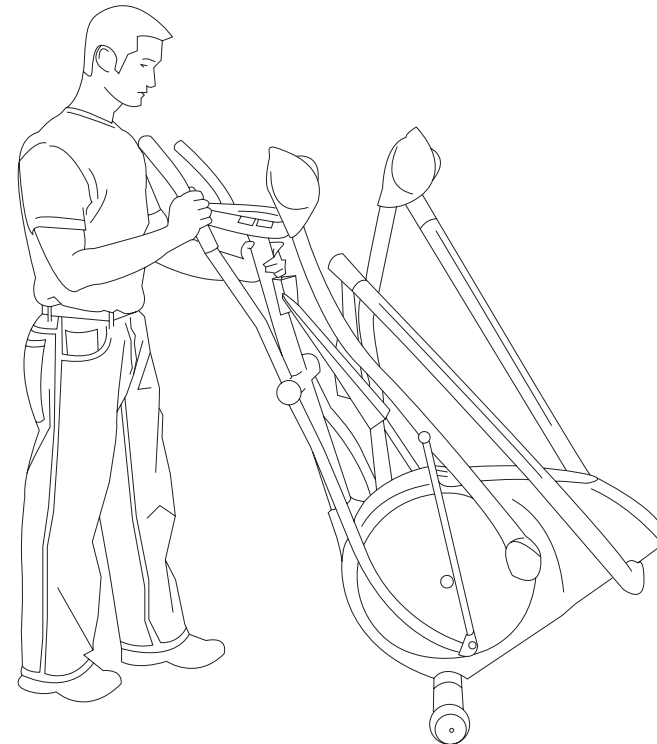

CAUTION! Our elliptical trainers are well built and heavy, weighing up to 200lbs.! Use care and additional help if necessary when moving.

FOOT POSITION

When using your elliptical trainer, you may notice that your heel raises off of the foot pad. This is a natural walking or running motion and you should not try to prevent this.

COMMON PRODUCT QUESTIONS

ARE THE SOUNDS MY ELLIPTICAL TRAINER MAKES NORMAL?

Our elliptical trainers are some of the quietest available because they use belt drives and friction free magnetic resistance. We use the highest grade bearings and belts to minimize noise. However, because the resistance system itself is so quiet, you will occasionally hear other slight mechanical noises. Unlike older, louder technologies, there are no fans, friction belts, or alternator noises to mask these sounds on our elliptical trainers. These mechanical noises, which may or may not be intermittent, are normal and are caused by the transfer of significant amounts of energy to a rapidly spinning flywheel. All bearings, belts and other rotating parts will generate some noise which will transmit through the casing and frame. It is also normal for these sounds to change slightly during a workout and over time because of thermal expansion of the parts.

WHY IS THE ELLIPTICAL TRAINER I HAD DELIVERED LOUDER THAN THE ONE AT THE STORE?

All fitness products seem quieter in a large store showroom because there is generally more background noise than in your home. Also, there will be less reverberation on a carpeted concrete floor than on a wood overlay floor. Sometimes a heavy rubber mat will help reduce reverberation through the floor. If a fitness product is placed close to a wall, there will be more reflected noise.

HOW LONG WILL THE DRIVE BELT LAST?

The computer modeling we have done indicated virtually thousands of maintenance free hours. Belts are now commonly used in far more demanding applications such as motorcycle drives.

CAN I MOVE THE ELLIPTICAL TRAINER EASILY ONCE IT IS ASSEMBLED?

Your elliptical trainer has a pair of transport wheels built into the front legs. It is easy to move your elliptical trainer by rolling it on the front transport wheels. It is important that you place your elliptical trainer in a comfortable and inviting room. Your elliptical trainer is designed to use minimal floor space. Many people will place their elliptical trainers facing the TV or a picture window. If at all possible, avoid putting your elliptical trainer in a unfinished basement. To make exercise a desirable daily activity for you, the elliptical trainer should be in a attractive setting.

PROBLEM: Erratic or Inconsistent heart rate Readout.

SOLUTION: Check your exercise environment for sources of interference such as high power lines, large motors, etc.

You may experience an erratic readout under the following conditions:

- Gripping the heart rate handlebars too tight. Try to maintain moderate pressure while holding onto the heart rate handlebars.
- Constant movement and vibration due to constantly holding the heart rate grips while exercising.
- When you are breathing heavily during a workout.
- When your hands are constricted by wearing a ring.
- When your hands are dry or cold. Try moistening your palms or rubbing them together to warm.
- Anyone with heavy arrhythmia.
- Anyone with arteriosclerosis or peripheral circulation disorder.
- Anyone whose skin on the measuring palms is especially thick.

Note: Outside interference sources such as computers, motors and fluorescent lights may cause the heart rate reading to be erratic.

1-800-4-MY-HOME® (1-800-469-4663)

Call anytime, day or night (U.S.A. and Canada)

www.sears.com www.sears.ca

Sears Parts & Repair Center.

1-800-488-1222

Call anytime, day or night (U.S.A. only)

KNOW YOUR CORE ELLIPTICAL

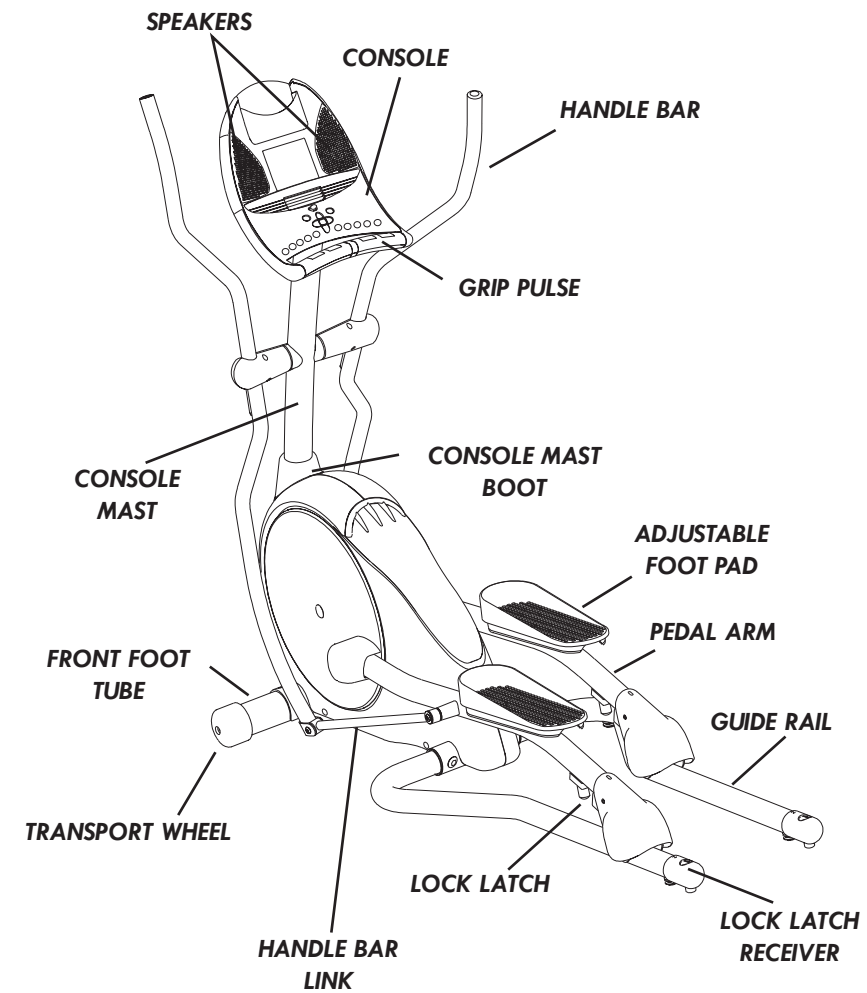

QUICK START UP

Simply press the 'Start' button to begin exercising. The program will automatically default to the Manual program unless another program is selected.

CD/MP3 PLAYER HOLDER

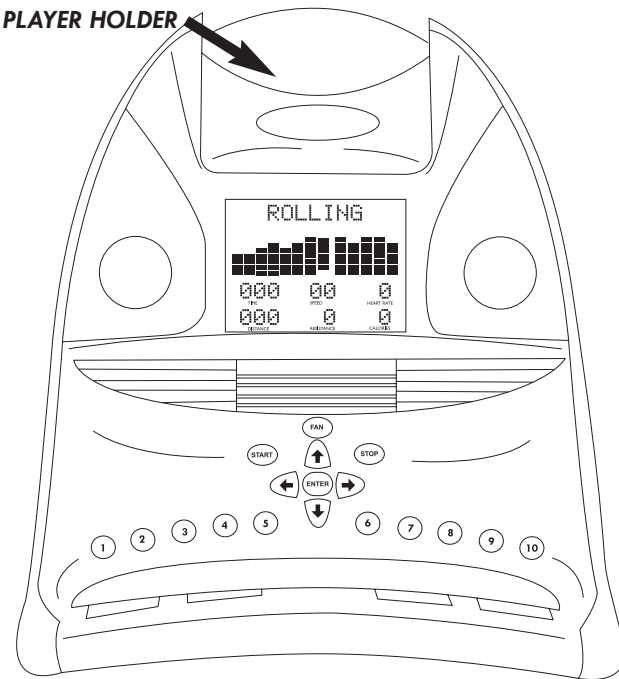

RESET

Press and hold the Stop button to reset the elliptical trainer.

LOCATING THE SPEAKER INPUT JACK

Compatible with AM/FM and cassette, etc.

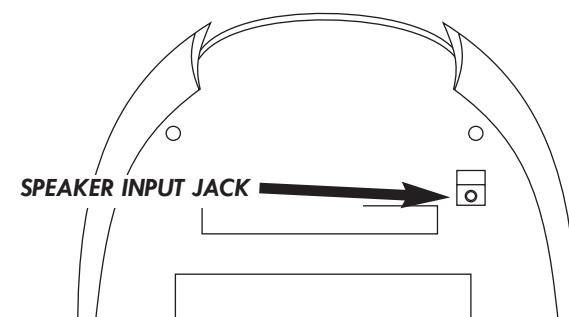

TROUBLESHOOTING YOUR ELLIPTICAL TRAINER

TIPS

Your elliptical trainer is designed to be reliable and maintenance free. However, if you do experience problems with your elliptical, please reference the troubleshooting guide listed below.

PROBLEM: There is no display on the console.

SOLUTION: Remove the console and verify that the console cable is attached properly, making sure that the cable is securely inserted into the console.

PROBLEM: The elliptical trainer makes a squeaking or chirping noise.

SOLUTION: Loosen all bolts attached during the assembly process, grease the threads and tighten again.

PROBLEM: The resistance levels seem to be incorrect, seeming too hard or too easy.

SOLUTION: Reset the console and allow the resistance to reset to the default position. Restart the console and retry the resistance levels.

PULSE Zone™ CHART

TARGET HEART RATE ZONE

Your 'Target Heart Rate Zone' is a percentage of your maximum heart rate. Target Zones will vary for each individual, depending on age, current level of conditioning, and personal fitness goals. The American Heart Association recommends working-out at a 'Target Heart Rate Zone' of between 60% and 75% of your maximum heart rate. See the chart below for convenient reference. **EXAMPLE** for a 42-year old user: find AGE along the bottom of the chart (round to 40), follow AGE column up to the TARGET ZONE BAR. RESULTS: 60% of maximum Hear Rate = 108 Beats Per Minute, 75% of maximum Heart Rate = 135 Beat Per Minute.

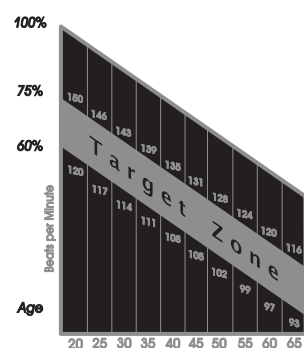

USING YOUR PULSE Zone™ PROGRAM

Once the Pulse Zone program is selected, press 'Select'. Using the chart on page 21, determine your target heart rate. Your target heart rate should be set at a number that you will be able to exercise at throughout the majority of your workout. To adjust your target heart rate, press the plus (+) or minus (-) Speed buttons.

Once you have chosen your target heart rate, press 'Select'. Press the plus (+) or minus (-) speed buttons to adjust your time. Once you choose your time, press the 'Start' button and begin your workout.

After the 5 minute warm up period, the elevation level will increase gradually to get the user to the entered target heart rate zone. Once the user is at the target heart rate zone, plus or minus 5 beats, the elevation level will remain at the current resistance level.

If the user is more than 25 beats per minute above the target heart rate zone, the console will shut down for safety reasons.

The last five minutes of the program will begin the cool down period. At this time, the program will gradually decrease the resistance level to give the user a smooth cool down.

PROGRAMMING

SELECTING OPTIONAL FEEDBACK

Press the 'ENTER' button on the console to scroll through and view your speed, watts and rpms.

FINISHING YOUR WORKOUT

Remember to gradually slow down your pace before stopping your workout. The machine will not stop moving if you stop your feet abruptly. After you have finished your workout, the console will 'beep' several times to let you know your workout is finished.

DISPLAY

TIME

Shown as Minutes:Seconds. View the time remaining or the time elapsed in your workout.

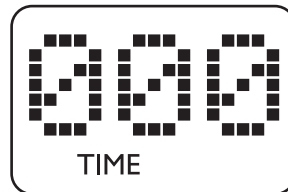

DISTANCE

Shown as Miles. View the accumulated distance during your workout.

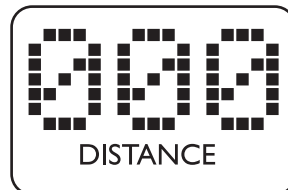

CALORIES

Shown as total accumulated calories burned during your workout.



RPM

Shown as Revolutions per Minute. Improve striding technique while reducing leg muscle fatigue by striding between 60 & 70 RPM.



MONITORING YOUR HEART RATE

HEART RATE HANDLEBAR

Place the palm of your hands directly on the heart rate handlebars. Both hands must grip the bars for your heart rate to register. When gripping the handlebars, do not grip tightly. Holding the grips tightly may elevate your blood pressure. Try to maintain moderate pressure while holding onto the heart rate handlebars. It is recommended that you hold the handlebars only long enough to see your heart rate readout on the console. You may experience an erratic readout if consistently holding the handlebars.

WARNING!

The heart rate function is not a medical device. Various factors may affect the accuracy of your heart rate reading. The heart rate reading is intended only as an exercise aid.

USING YOUR ADVENTURE PROGRAM

Your Adventure Program is designed to allow you to create your own programming, with the ability to save your program settings for future workouts. To use your Adventure Program, follow these instructions:

1. Once the Adventure Program has been selected, press 'Enter'.
2. Choose your desired time using the 'Up' or 'Down' buttons and press 'Enter'.
3. Choose your desired resistance using the 'Up' or 'Down' buttons and press 'Enter'. You will need to select a resistance for all 15 segments, pressing 'Enter' after each segment.
4. Once you have chosen your desired resistance level for all 15 segments, press 'Start' to begin your program. At this time, your program has been successfully saved into memory, and can be used for future workouts.
5. To reset your program information and delete it from memory, press and hold the 'Enter' button for 5 seconds once you have selected the Adventure Program in the start menu.
6. While using your saved program in the Adventure Program, you are able to adjust the resistance, but any changes will not be saved.

USING YOUR RACE PROGRAM

Your Race Program is designed to add motivation to a workout by allowing you to compete against a selected pacer. To use your Race Program, follow these instructions:

1. Choose the Race program by either pressing the 'Up' or 'Down' buttons or by pressing quick resistance key number 14. Press 'Enter'.
2. Choose the desired Pace (average speed) using the 'Up' or 'Down' buttons. There are a total of 17 Pace levels to choose from, ranging from 6 mph to 22 mph in increments of 1.0 mph, with 6.0 mph being the lowest and 22 mph being the highest. Once the desired Pace is selected, press 'Enter'.
3. Choose the desired Distance by pressing the 'Up' or 'Down' buttons. Press 'Enter'.
4. Choose your weight by pressing the 'Up' or 'Down' buttons. Press 'Enter'.
5. Press 'Start' and begin your Race Program.

The time of the program will default accordingly to the pace (average speed) and distance that you entered. After the Race Program has started, press the 'Up' or 'Down' buttons or the quick resistance keys to adjust your resistance (levels 1-20). Your goal in this program is to beat the pacer to the finish line by covering an equal distance at a faster pace.

The top row of bars shows the computer pacer position. The bottom row of bars indicates your position. If you trail the pacer, you should pedal at a faster speed to catch and pass the pacer.

If you beat the pacer to the finish line, the screen will flash "Time Over" and the program will end. **Note:** If you beat the pacer to the finish line, you will complete the program before the projected finish time. If the pacer beats you to the finish line, the entire program time will elapse.

DISPLAY

RESISTANCE

During a workout, the amount of resistance can be adjusted by pressing the plus 'Up' or 'Down' buttons or the quick resistance keys on the console. The resistance levels vary from level 1 to 20 quick resistance keys (level 1 being the easiest and level 20 being the most difficult).



WATTS

A measurement of your expending energy. May be used to evaluate and quantify your fitness progress over time.

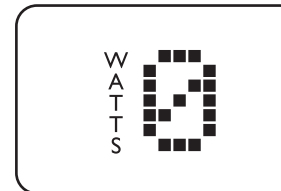

HEART RATE

Shown as Beats per Minute. You can monitor your heart rate at any time during your workout by holding the heart rate grips.



PROFILE

Allows you to view your program intensity while you exercise. Each horizontal row of bars represents 2 resistance levels.

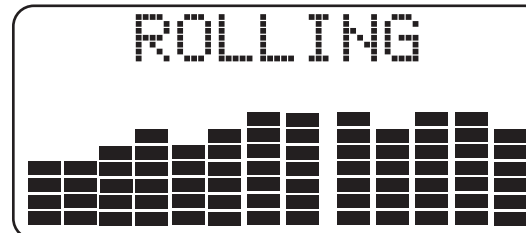

CHOOSING A PROGRAM

Press 'ENTER' with the program text scrolling, press the arrow keys to scroll through the different programs. Press enter to choose your desired program. Once you choose your program, you will see the resistance level scrolling across the screen.

CHOOSING A RESISTANCE

With the resistance text scrolling, press the arrow keys to scroll through the different resistance levels. Press enter to choose your desired resistance. Once you choose your resistance, you will see the time scrolling across the screen.

CHOOSING A TIME

With the time text scrolling, press the arrow keys to scroll through the different times. Press enter to choose your desired time. Once you choose your time, press the 'Enter' button to choose your desired weight.

CHOOSING YOUR WEIGHT

With the weight text scrolling, press the arrow keys to scroll through the different weights. Press enter to choose your desired weight. Once you choose your weight, press the 'Start' button and begin your workout.

FINISHING YOUR WORKOUT

Press the 'Stop' button to pause your workout, press and hold to reset your workout. Remember to gradually slow down your pace before stopping or pausing your workout. The machine will not stop moving if you stop your feet abruptly. After you have finished your workout, the console will retain the data from your workout for 45 seconds before resetting.

ROCK CLIMB: Resistance, time defaults to 30 minutes

Level 1	1	2	3	4	5	6	7	8	9	10	11	12	13	14	15	16	17	18	19	20	21	22	23	24	25	26	27	28	29	30
Level 2	1	1	2	3	3	4	4	5	5	6	6	7	7	8	8	9	9	10	10	11	11	12	12	13	13	14	14	15	15	16
Level 3	1	2	2	3	4	4	5	6	6	7	8	8	9	10	10	11	12	12	13	14	14	15	16	16	17	18	18	19	20	
Level 4	1	2	3	4	5	6	6	7	8	9	10	10	11	12	13	13	14	15	16	17	17	18	19	20	20	21	22	23	24	
Level 5	2	3	4	5	6	7	8	9	10	10	11	12	13	14	15	16	17	18	19	20	20	21	22	23	24	25	26	27	28	
Level 6	2	3	4	5	6	7	8	9	10	11	12	13	14	15	16	17	18	19	20	20	21	22	23	24	25	26	27	28	29	
Level 7	2	3	4	5	6	7	8	9	10	11	12	13	14	15	16	17	18	19	20	20	21	22	23	24	25	26	27	28	29	
Level 8	2	3	4	5	6	7	8	9	10	11	12	13	14	15	16	17	18	19	20	20	21	22	23	24	25	26	27	28	29	
Level 9	3	4	5	6	7	8	9	10	11	12	13	14	15	16	17	18	19	20	20	21	22	23	24	25	26	27	28	29	30	
Level 10	3	4	5	6	7	8	9	10	11	12	13	14	15	16	17	18	19	20	20	21	22	23	24	25	26	27	28	29	30	
Level 11	3	4	5	6	7	8	9	10	11	12	13	14	15	16	17	18	19	20	20	21	22	23	24	25	26	27	28	29	30	
Level 12	3	4	5	6	7	8	9	10	11	12	13	14	15	16	17	18	19	20	20	21	22	23	24	25	26	27	28	29	30	
Level 13	5	9	13	13	14	15	16	17	18	19	20	20	21	22	23	24	25	26	27	28	29	30	30	31	32	33	34	35	36	
Level 14	5	9	13	14	15	16	17	18	19	20	20	21	22	23	24	25	26	27	28	29	30	30	31	32	33	34	35	36	37	
Level 15	5	9	13	14	15	16	17	18	19	20	20	21	22	23	24	25	26	27	28	29	30	30	31	32	33	34	35	36	37	
Level 16	5	9	13	14	15	16	17	18	19	20	20	21	22	23	24	25	26	27	28	29	30	30	31	32	33	34	35	36	37	

PROGRAM PROFILES

MANUAL

Customized workouts, allowing the user to adjust resistance level to the user's preference.

CROSS COUNTRY

Improves your strength, speed, and endurance by raising and lowering the resistance levels throughout your workout to involve both your heart and muscles.

HILL RUN

Maintains weight by gradually raising and lowering the resistance level to gradually raise and lower your heart rate.

AFTER BURNER

Promotes weight loss by raising and lowering the resistance level, while keeping you in your fat burning zone.

HILL CLIMB

Simulates a gradual hill climb to strengthen your leg muscles and improve your cardiovascular health.

AFTER BURNER: Resistance; time defaults to 30 minutes

Level 1	1	2	3	4	5	6	7	8	9	10	11	12	13	14	15	16	17	18	19	20	21	22	23	24	25	26	27	28	29	30	
Level 2	1	1	2	3	4	5	6	7	8	9	10	11	12	13	14	15	16	17	18	19	20	21	22	23	24	25	26	27	28	29	30
Level 3	1	1	2	3	4	5	6	7	8	9	10	11	12	13	14	15	16	17	18	19	20	21	22	23	24	25	26	27	28	29	30
Level 4	1	2	3	4	5	6	7	8	9	10	11	12	13	14	15	16	17	18	19	20	21	22	23	24	25	26	27	28	29	30	
Level 5	2	3	4	5	6	7	8	9	10	11	12	13	14	15	16	17	18	19	20	21	22	23	24	25	26	27	28	29	30		
Level 6	2	3	4	5	6	7	8	9	10	11	12	13	14	15	16	17	18	19	20	21	22	23	24	25	26	27	28	29	30		
Level 7	2	3	4	5	6	7	8	9	10	11	12	13	14	15	16	17	18	19	20	21	22	23	24	25	26	27	28	29	30		
Level 8	2	3	4	5	6	7	8	9	10	11	12	13	14	15	16	17	18	19	20	21	22	23	24	25	26	27	28	29	30		
Level 9	3	4	5	6	7	8	9	10	11	12	13	14	15	16	17	18	19	20	21	22	23	24	25	26	27	28	29	30			
Level 10	3	4	5	6	7	8	9	10	11	12	13	14	15	16	17	18	19	20	21	22	23	24	25	26	27	28	29	30			
Level 11	3	4	5	6	7	8	9	10	11	12	13	14	15	16	17	18	19	20	21	22	23	24	25	26	27	28	29	30			
Level 12	3	4	5	6	7	8	9	10	11	12	13	14	15	16	17	18	19	20	21	22	23	24	25	26	27	28	29	30			
Level 13	3	4	5	6	7	8	9	10	11	12	13	14	15	16	17	18	19	20	21	22	23	24	25	26	27	28	29	30			
Level 14	5	9	13	15	16	17	18	19	20	21	22	23	24	25	26	27	28	29	30												
Level 15	5	9	13	15	16	17	18	19	20	21	22	23	24	25	26	27	28	29	30												
Level 16	5	9	13	15	16	17	18	19	20	21	22	23	24	25	26	27	28	29	30												

HILL CLIMB: Resistance; time defaults to 30 minutes

Level 1	1	2	3	4	5	6	7	8	9	10	11	12	13	14	15	16	17	18	19	20	21	22	23	24	25	26	27	28	29	30	
Level 2	1	1	2	3	4	5	6	7	8	9	10	11	12	13	14	15	16	17	18	19	20	21	22	23	24	25	26	27	28	29	30
Level 3	1	2	3	4	5	6	7	8	9	10	11	12	13	14	15	16	17	18	19	20	21	22	23	24	25	26	27	28	29	30	
Level 4	1	2	3	4	5	6	7	8	9	10	11	12	13	14	15	16	17	18	19	20	21	22	23	24	25	26	27	28	29	30	
Level 5	2	3	4	5	6	7	8	9	10	11	12	13	14	15	16	17	18	19	20	21	22	23	24	25	26	27	28	29	30		
Level 6	2	3	4	5	6	7	8	9	10	11	12	13	14	15	16	17	18	19	20	21	22	23	24	25	26	27	28	29	30		
Level 7	2	3	4	5	6	7	8	9	10	11	12	13	14	15	16	17	18	19	20	21	22	23	24	25	26	27	28	29	30		
Level 8	2	3	4	5	6	7	8	9	10	11	12	13	14	15	16	17	18	19	20	21	22	23	24	25	26	27	28	29	30		
Level 9	3	4	5	6	7	8	9	10	11	12	13	14	15	16	17	18	19	20	21	22	23	24	25	26	27	28	29	30			
Level 10	3	4	5	6	7	8	9	10	11	12	13	14	15	16	17	18	19	20	21	22	23	24	25	26	27	28	29	30			
Level 11	3	4	5	6	7	8	9	10	11	12	13	14	15	16	17	18	19	20	21	22	23	24	25	26	27	28	29	30			
Level 12	3	4	5	6	7	8	9	10	11	12	13	14	15	16	17	18	19	20	21	22	23	24	25	26	27	28	29	30			
Level 13	5	9	13	15	16	17	18	19	20	21	22	23	24	25	26	27	28	29	30												
Level 14	5	9	13	15	16	17	18	19	20	21	22	23	24	25	26	27	28	29	30												
Level 15	5	9	13	15	16	17	18	19	20	21	22	23	24	25	26	27	28	29	30												
Level 16	5	9	13	15	16	17	18	19	20	21	22	23	24	25	26	27	28	29	30												

